



> PORTÕES SECCIONADOS

PUERTAS SECCIONALES PORTES SECTIONNELLES SECTIONAL DOORS



- Em vigor a partir de 02-06-2022. / Preços sujeitos a IVA à taxa legal em vigor. Toda a informação contida neste documento está sujeita a alterações sem aviso prévio.
- En vigor desde el 02-06-2022. / Los precios están sujetos a la tasa de IVA legal vigente. Toda la información aquí contenida está sujeta a cambios sin previo aviso.
- En vigueur à partir du 02-06-2022. / Les prix sont soumis à la TVA en vigueur. Toute l'information contenue dans ce document est sujette à changement sans préavis.
- Effective 02-06-2022. / Prices are subject to the legal VAT rate in effect. The right is reserved to change prices and specifications without prior notice.



ÍNDICE | INDEX

04 **A EMPRESA**
LA EMPRESA
LA SOCIÉTÉ
THE COMPANY

06 **MODELOS**
MODELOS
MODÈLES
MODELS

48 **ESPECIFICAÇÕES TÉCNICAS**
ESPECIFICACIONES TÉCNICAS
SPÉCIFICATIONS TECHNIQUES
TECHNICAL SPECIFICATIONS

74 **AUTOMATAÇÃO**
AUTOMACIÓN
AUTOMATION
AUTOMATION

84 **INFORMAÇÃO ADICIONAL**
INFORMACIÓN ADICIONAL
INFORMATIONS COMPLÉMENTAIRES
ADDITIONAL INFORMATION



> A EMPRESA

LA EMPRESA
LA SOCIÉTÉ
THE COMPANY



PT

LM PERFIS | Indústria de Perfis e Portas, S.A., junto com a sua antecessora LMS, Lda., foi pioneira no fabrico de Portas Seccionadas, segmento de mercado de que é líder há 30 anos.

Recentemente foi adquirida uma linha de produção para garantir a qualidade e prazos de entrega a que habituámos os nossos clientes.

ES

LM PERFIS | Indústria de Perfis e Portas, S.A., junto con su predecesora LMS, Lda., fue pionera en la fabricación de Puertas Seccionales, mercado de que es líder desde hace 30 años.

Recientemente se ha adquirido una línea de producción para garantizar la calidad y los plazos de entrega a los que están acostumbrados nuestros clientes



FR

LM PERFIS | INDÚSTRIA DE PERFIS E PORTAS, S.A., avec son prédécesseur LMS, Lda, a été pionnier de la fabrication de Portes Sectionnelles au Portugal, marché dont il est le leader depuis 30 ans.

Une ligne de production a été récemment acquise pour garantir la qualité et les délais de livraison auxquels nos clients sont habitués.

EN

LM PERFIS | Indústria de Perfis e Portas, S.A., along with its predecessor LMS, Lda., was a pioneer in the manufacture of sectional doors, a market segment in which it has been leader for 30 years.

A production line has recently been acquired to guarantee the quality, delivery times that our clients are used to



ONDE ESTAMOS

**DONDE ESTAMOS
OÙ NOUS SOMMES
WHERE WE ARE**

PORTUGAL | ESPAÑA | FRANCE | LUXEMBOURG | SUISSE

PT

Localizada no centro de Portugal, onde possui instalações modernas criadas de raiz, com base numa filosofia de otimização e fluxo. Com frota própria, assegura a total cobertura da Península Ibérica e França.

FR

Ses installations modernes se localisent sur le centre du Portugal, ce qui est point stratégique pour le transport tant de la matière première comme du produit fini. Toutes les livraisons sur la Péninsule Ibérique et la France sont assurées par ses propres camions.

ES

Situada en el centro de Portugal, cuenta con unas modernas instalaciones creadas desde cero, basadas en una filosofía de optimización y fluidez. Con su propia flota, garantiza una cobertura total de la Península Ibérica y Francia.

EN

Located in central Portugal, where it has modern facilities created from scratch, based on a philosophy of optimization and flow. With its own fleet, it ensures total coverage of the Iberian Peninsula and France.





> MODELOS

MODELOS | MODÈLES | MODELS

> LM SABLÉ NOIR



Painel Standard Panel Estándar Panneau Standard Standard Panel			
	preto negro noir black	RAL 9005	m ²

*O painel não pode ser pintado
Panel no se puede pintar
Le panneau ne peut pas être peint
Panel can not be painted

Painel Standard Panel Estándar Panneau Standard Standard Panel			
	preto negro noir black	RAL 9005	m ²

*O painel não pode ser pintado
Panel no se puede pintar
Le panneau ne peut pas être peint
Panel can not be painted



PT Painel sandwich

Em secções de 500mm ou 610mm de altura útil e espessura de 40mm
Interior em poliuretano expandido de alta densidade e isento de CFC
Encaixe anti-dedo prevenindo qualquer hipótese de entalamento durante a operação do portão
Vedante em EPDM embutido no macho do painel
Chapas de reforço em aço galvanizado, inferior e superior, no interior do painel
Grande isolamento térmico e acústico

Cara exterior

Chapa de aço de 0,4mm pré-lacada e com tratamento anti-oxidação
Textura lisa

Cara interior

Chapa de aço de 0,4mm pré-lacada e com tratamento anti-oxidação
Canelado fino e textura 'stucco', branco RAL 9010

Faturação mínima: 5 m²

ES Panel sandwich

Con secciones de 500mm o 610mm de altura útil y espesor de 40mm
Interior de poliuretano expandido de gran densidad y libre de CFC
Encaje antipinzamiento preveniendo cualquier situación de riesgo durante su movimentación
Goma de EPDM incrustada en el macho del panel
Área de refuerzo, inferior y superior, de acero galvanizado, en el interior del panel
Gran aislamiento térmico y acústico

Cara exterior

Chapa de acero liso de 0,4mm prelacada y con tratamiento antioxidación
Textura lisa

Cara interior

Chapa liso de acero de 0,4mm prelacada y con tratamiento antioxidación
Acanalado fino y textura 'stucco', blanco RAL 9010

Facturación mínima: 5 m²



FR Panneau sandwich

En section de 500mm ou 610mm de hauteur utile et épaisseur de 40mm
 Intérieur en polyuréthane à haute densité et dépourvu de CFC
 Emboîtement anti-pince doigt, évitant toute possibilité de coincement pendant la marche de la porte
 Plaques de renfort en acier galvanisé, inférieures et supérieures, à l'intérieur du panneau
 Joint EPDM encastré dans la partie mâle du panneau
 Forte isolation thermique et acoustique

Coté extérieur

Tôle d'acier lisse de 0,4mm pré-laqué et avec traitement antioxydant
 Texture lisse

Coté intérieur:

Tôle d'acier de 0,4mm pré-laqué et avec traitement antioxydant
 Rainuré fin et texture 'stucco', blanc RAL 9010

Minimum de facturation: 5 m²

EN Sandwich panel

In sections of 500mm or 610mm height and thickness of 40mm
 Interior of high density expanded polyurethane, CFC free
 Safe-finger interlocking system preventing any trapping episodes during door's moving cycle
 EPDM rubber seal grooved into the panel's top
 Reinforced panel's structure with galvanized steel strips in top and bottom ends of the panel
 Great thermal and acoustic insulation

Outer appearance:

0,4mm galvanized steel plate, pre-powdercoated and with anti-corrosion treatment
 Smooth texture

Inner appearance:

0,4mm galvanized steel plate, pre-powdercoated and with anti-corrosion treatment
 Thin ribbed pattern and 'stucco' emboss, pre-powdercoated white RAL 9010

Minimum charge: 5 m²

Painel Standard Panel Estándar Panneau Standard Standard Panel			
	cinza		
PS.040CA25	gris	RAL 7016	m ²
	gris		
	grey		

*O painel não pode ser pintado
 Panel no se puede pintar
 Le panneau ne peut pas être peint
 Panel can not be painted

Painel Standard Panel Estándar Panneau Standard Standard Panel			
	cinza		
PL.040CA25	gris	RAL 7016	m ²
	gris		
	grey		

*O painel não pode ser pintado
 Panel no se puede pintar
 Le panneau ne peut pas être peint
 Panel can not be painted



PT Painel sandwich

Em secções de 500mm ou 610mm de altura útil e espessura de 40mm
 Interior em poliuretano expandido de alta densidade e isento de CFC
 Encaixe anti-dedo prevenindo qualquer hipótese de entalamento durante a operação do portão
 Vedante em EPDM embutido no macho do painel
 Chapas de reforço em aço galvanizado, inferior e superior, no interior do painel
 Grande isolamento térmico e acústico

Cara exterior

Chapa de aço de 0,4mm pré-lacada e com tratamento anti-oxidação
 Textura lisa

Cara interior

Chapa de aço de 0,4mm pré-lacada e com tratamento anti-oxidação
 Canelado fino e textura 'stucco', branco RAL 9010

Faturação mínima: 5 m²

ES Panel sandwich

Con secciones de 500mm o 610mm de altura útil y espesor de 40mm
 Interior de poliuretano expandido de gran densidad y libre de CFC
 Encaje antipinzamiento preveniendo cualquier situación de riesgo durante su movimentación
 Goma de EPDM incrustada en el macho del panel
 Área de refuerzo, inferior y superior, de acero galvanizado, en el interior del panel
 Gran aislamiento térmico y acústico

Cara exterior

Chapa de acero liso de 0,4mm prelacada y con tratamiento antioxidación
 Textura lisa

Cara interior

Chapa lisa de acero de 0,4mm prelacada y con tratamiento antioxidación
 Acanalado fino y textura 'stucco', blanco RAL 9010

Facturación mínima: 5 m²

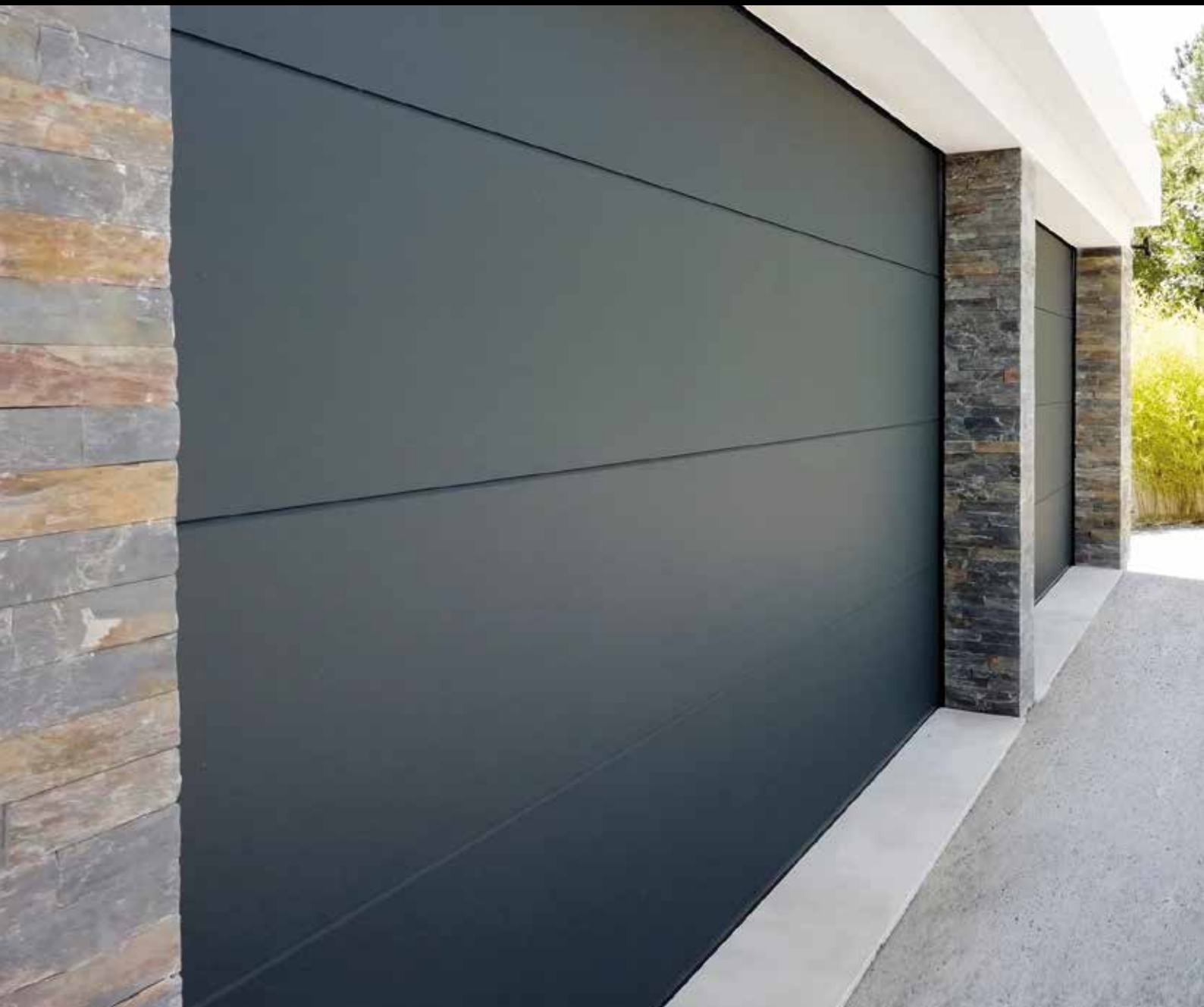

FR Panneau sandwich

En section de 500mm ou 610mm de hauteur utile et épaisseur de 40mm
 Intérieur en polyuréthane à haute densité et dépourvu de CFC
 Emboîtement anti-pince doigt, évitant toute possibilité de coincement pendant la marche de la porte
 Plaques de renfort en acier galvanisé, inférieures et supérieures, à l'intérieur du panneau
 Joint EPDM encastré dans la partie mâle du panneau
 Forte isolation thermique et acoustique

Coté extérieur

Tôle d'acier lisse de 0,4mm pré-laqué et avec traitement antioxydant
 Texture lisse

Coté intérieur:

Tôle d'acier de 0,4mm pré-laqué et avec traitement antioxydant
 Rainuré fin et texture 'stucco', blanc RAL 9010

Minimum de facturation: 5 m²

EN Sandwich panel

In sections of 500mm or 610mm height and thickness of 40mm
 Interior of high density expanded polyurethane, CFC free
 Safe-finger interlocking system preventing any trapping episodes during door's moving cycle
 EPDM rubber seal grooved into the panel's top
 Reinforced panel's structure with galvanized steel strips in top and bottom ends of the panel
 Great thermal and acoustic insulation

Outer appearance:

0,4mm galvanized steel plate, pre-powdercoated and with anti-corrosion treatment
 Smooth texture

Inner appearance:

0,4mm galvanized steel plate, pre-powdercoated and with anti-corrosion treatment
 Thin ribbed pattern and 'stucco' emboss, pre-powdercoated white RAL 9010

Minimum charge: 5 m²

Painel Standard
Panel Estándar
Panneau Standard
Standard Panel



PS.040CA91

m²

*O painel não pode ser pintado
El panel no se puede pintar
Le panneau ne peut pas être peint
The panel can not be painted

Painel Standard
Panel Estándar
Panneau Standard
Standard Panel



PL..040CA91

m²

*O painel não pode ser pintado
El panel no se puede pintar
Le panneau ne peut pas être peint
The panel can not be painted



PT Painel sandwich

Em secções de 500mm ou 610mm de altura útil e espessura de 40mm
Interior em poliuretano expandido de alta densidade e isento de CFC
Encaixe anti-dedo prevenindo qualquer hipótese de entalamento durante a operação do portão
Vedante em EPDM embutido no macho do painel
Chapas de reforço em aço galvanizado, inferior e superior, no interior do painel
Grande isolamento térmico e acústico

Cara exterior

Chapa de aço de 0,4mm pré-lacada e com tratamento anti-oxidação
Textura lisa

Cara interior

Chapa de aço de 0,4mm pré-lacada e com tratamento anti-oxidação
Canelado fino e textura 'stucco', branco RAL 9010

Faturação mínima: 5 m²

ES Panel sandwich

Con secciones de 500mm o 610mm de altura útil y espesor de 40mm
Interior de poliuretano expandido de gran densidad y libre de CFC
Encaje antipinzamiento preveniendo cualquier situación de riesgo durante su movimentación
Goma de EPDM incrustada en el macho del panel
Área de refuerzo, inferior y superior, de acero galvanizado, en el interior del panel
Gran aislamiento térmico y acústico

Cara exterior

Chapa de acero liso de 0,4mm prelacada y con tratamiento antioxidación
Textura lisa

Cara interior

Chapa liso de acero de 0,4mm prelacada y con tratamiento antioxidación
Acanalado fino y textura 'stucco', blanco RAL 9010

Facturación mínima: 5 m²

**FR Panneau sandwich**

En section de 500mm ou 610mm de hauteur utile et épaisseur de 40mm
 Intérieur en polyuréthane à haute densité et dépourvu de CFC
 Emboîtement anti-pince doigt, évitant toute possibilité de coincement pendant la marche de la porte
 Plaques de renfort en acier galvanisé, inférieures et supérieures, à l'intérieur du panneau
 Joint EPDM encastré dans la partie mâle du panneau
 Forte isolation thermique et acoustique

Coté extérieur

Tôle d'acier lisse de 0,4mm pré-laqué et avec traitement antioxydant
 Texture lisse

Coté intérieur:

Tôle d'acier de 0,4mm pré-laqué et avec traitement antioxydant
 Rainuré fin et texture 'stucco', blanc RAL 9010

Minimum de facturation: 5 m²

EN Sandwich panel

In sections of 500mm or 610mm height and thickness of 40mm
 Interior of high density expanded polyurethane, CFC free
 Safe-finger interlocking system preventing any trapping episodes during door's moving cycle
 EPDM rubber seal grooved into the panel's top
 Reinforced panel's structure with galvanized steel strips in top and bottom ends of the panel
 Great thermal and acoustic insulation

Outer appearance:

0,4mm galvanized steel plate, pre-powdercoated and with anti-corrosion treatment
 Smooth texture

Inner appearance:

0,4mm galvanized steel plate, pre-powdercoated and with anti-corrosion treatment
 Thin ribbed pattern and 'stucco' emboss, pre-powdercoated white RAL 9010

Minimum charge: 5 m²

Painel Standard Panel Estándar Panneau Standard Standard Panel	
PS.040CA94	Imitação inox escovado Imitación de acero inoxidable cepillado Imitation acier inoxydable brossé Brushed stainless steel imitation
	m ²

*O painel não pode ser pintado
 El panel no se puede pintar
 Le panneau ne peut pas être peint
 The panel can not be painted

Painel Standard Panel Estándar Panneau Standard Standard Panel	
PL.040CA94	Imitação inox escovado Imitación de acero inoxidable cepillado Imitation acier inoxydable brossé Brushed stainless steel imitation
	m ²

*O painel não pode ser pintado
 El panel no se puede pintar
 Le panneau ne peut pas être peint
 The panel can not be painted



PT Painel sandwich

Em secções de 500mm ou 610mm de altura útil e espessura de 40mm
 Interior em poliuretano expandido de alta densidade e isento de CFC
 Encaixe anti-dedo prevenindo qualquer hipótese de entalamento durante a operação do portão
 Vedante em EPDM embutido no macho do painel
 Chapas de reforço em aço galvanizado, inferior e superior, no interior do painel
 Grande isolamento térmico e acústico

Cara exterior

Chapa de aço de 0,4mm pré-lacada e com tratamento anti-oxidação
 Textura lisa

Cara interior

Chapa de aço de 0,4mm pré-lacada e com tratamento anti-oxidação
 Canelado fino e textura 'stucco', branco RAL 9010

Faturação mínima: 5 m²

ES Panel sandwich

Con secciones de 500mm o 610mm de altura útil y espesor de 40mm
 Interior de poliuretano expandido de gran densidad y libre de CFC
 Encaje antipinzamiento preveniendo cualquier situación de riesgo durante su movimentación
 Goma de EPDM incrustada en el macho del panel
 Área de refuerzo, inferior y superior, de acero galvanizado, en el interior del panel
 Gran aislamiento térmico y acústico

Cara exterior

Chapa de acero liso de 0,4mm prelacada y con tratamiento antioxidación
 Textura lisa

Cara interior

Chapa liso de acero de 0,4mm prelacada y con tratamiento antioxidación
 Acanalado fino y textura 'stucco', blanco RAL 9010

Facturación mínima: 5 m²

**FR Panneau sandwich**

En section de 500mm ou 610mm de hauteur utile et épaisseur de 40mm
 Intérieur en polyuréthane à haute densité et dépourvu de CFC
 Emboîtement anti-pince doigt, évitant toute possibilité de coincement pendant la marche de la porte
 Plaques de renfort en acier galvanisé, inférieures et supérieures, à l'intérieur du panneau
 Joint EPDM encastré dans la partie mâle du panneau
 Forte isolation thermique et acoustique

Coté extérieur

Tôle d'acier lisse de 0,4mm pré-laqué et avec traitement antioxydant
 Texture lisse

Coté intérieur:

Tôle d'acier de 0,4mm pré-laqué et avec traitement antioxydant
 Rainuré fin et texture 'stucco', blanc RAL 9010

Minimum de facturation: 5 m²

EN Sandwich panel

In sections of 500mm or 610mm height and thickness of 40mm
 Interior of high density expanded polyurethane, CFC free
 Safe-finger interlocking system preventing any trapping episodes during door's moving cycle
 EPDM rubber seal grooved into the panel's top
 Reinforced panel's structure with galvanized steel strips in top and bottom ends of the panel
 Great thermal and acoustic insulation

Outer appearance:

0,4mm galvanized steel plate, pre-powdercoated and with anti-corrosion treatment
 Smooth texture

Inner appearance:

0,4mm galvanized steel plate, pre-powdercoated and with anti-corrosion treatment
 Thin ribbed pattern and 'stucco' emboss, pre-powdercoated white RAL 9010

Minimum charge: 5 m²

Painel Standard Panel Estándar Panneau Standard Standard Panel	
PS.040CA93	Imitação de aço corten Imitación de acero corten Imitation acier corten Corten steel imitation
	m ²

*O painel não pode ser pintado
El panel no se puede pintar
Le panneau ne peut pas être peint
The panel can not be painted

Painel Standard Panel Estándar Panneau Standard Standard Panel	
PL.040CA93	Imitação de aço corten Imitación de acero corten Imitation acier corten Corten steel imitation
	m ²

*O painel não pode ser pintado
El panel no se puede pintar
Le panneau ne peut pas être peint
The panel can not be painted



PT Painel sandwich

Em secções de 500mm ou 610mm de altura útil e espessura de 40mm
Interior em poliuretano expandido de alta densidade e isento de CFC
Encaixe anti-dedo prevenindo qualquer hipótese de entalamento durante a operação do portão
Vedante em EPDM embutido no macho do painel
Chapas de reforço em aço galvanizado, inferior e superior, no interior do painel
Grande isolamento térmico e acústico

Cara exterior

Chapa de aço de 0,4mm pré-lacada e com tratamento anti-oxidação
Textura lisa

Cara interior

Chapa de aço de 0,4mm pré-lacada e com tratamento anti-oxidação
Canelado fino e textura 'stucco', branco RAL 9010

Faturação mínima: 5 m²

ES Panel sandwich

Con secciones de 500mm o 610mm de altura útil y espesor de 40mm
Interior de poliuretano expandido de gran densidad y libre de CFC
Encaje antipinzamiento preveniendo cualquier situación de riesgo durante su movimentación
Goma de EPDM incrustada en el macho del panel
Área de refuerzo, inferior y superior, de acero galvanizado, en el interior del panel
Gran aislamiento térmico y acústico

Cara exterior

Chapa de acero liso de 0,4mm prelacada y con tratamiento antioxidación
Textura lisa

Cara interior

Chapa liso de acero de 0,4mm prelacada y con tratamiento antioxidación
Acanalado fino y textura 'stucco', blanco RAL 9010

Facturación mínima: 5 m²

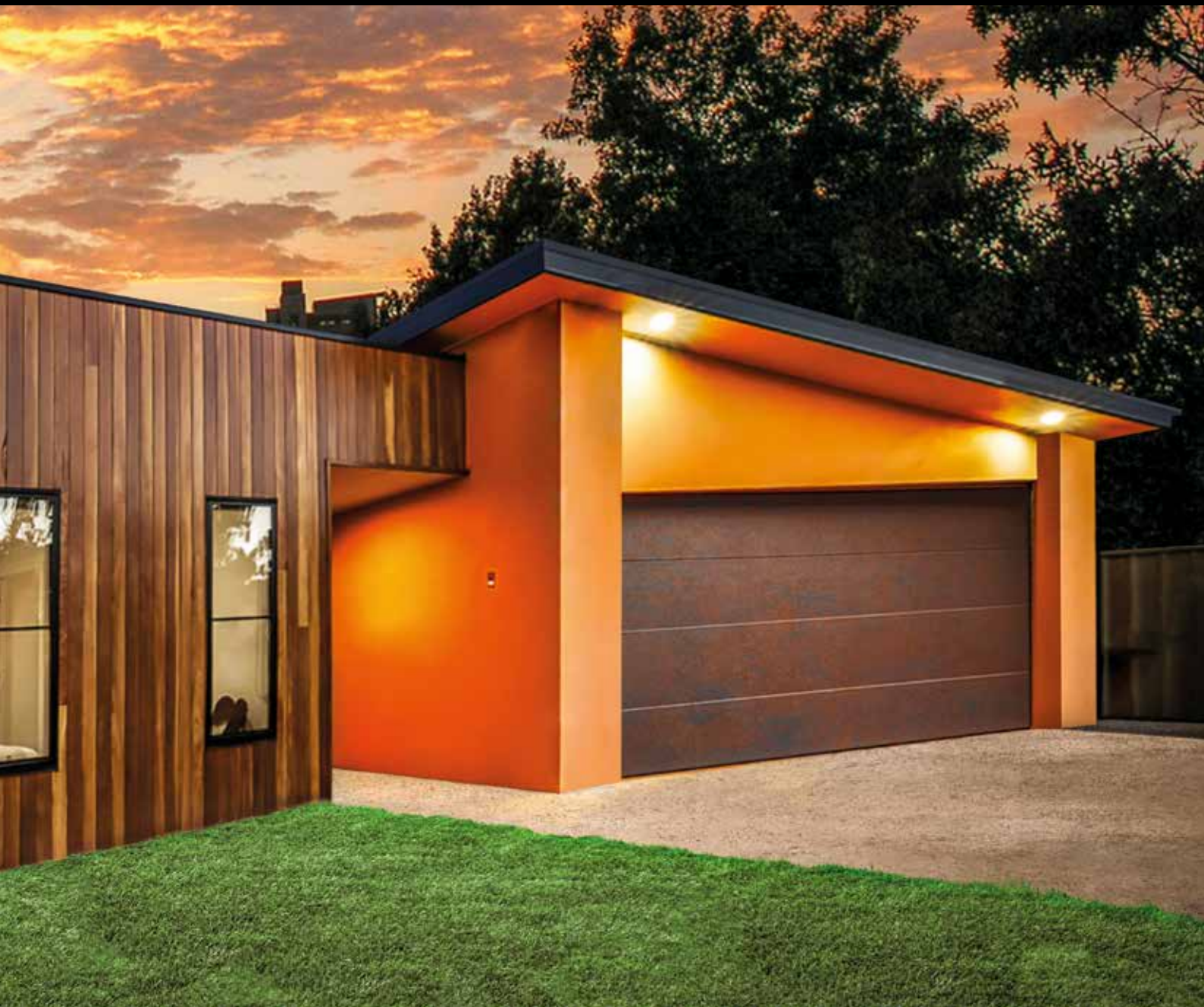
**FR Panneau sandwich**

En section de 500mm ou 610mm de hauteur utile et épaisseur de 40mm
 Intérieur en polyuréthane à haute densité et dépourvu de CFC
 Emboîtement anti-pince doigt, évitant toute possibilité de coincement pendant la marche de la porte
 Plaques de renfort en acier galvanisé, inférieures et supérieures, à l'intérieur du panneau
 Joint EPDM encastré dans la partie mâle du panneau
 Forte isolation thermique et acoustique

Coté extérieur

Tôle d'acier lisse de 0,4mm pré-laqué et avec traitement antioxydant
 Texture lisse

Coté intérieur:

Tôle d'acier de 0,4mm pré-laqué et avec traitement antioxydant
 Rainuré fin et texture 'stucco', blanc RAL 9010

Minimum de facturation: 5 m²

EN Sandwich panel

In sections of 500mm or 610mm height and thickness of 40mm
 Interior of high density expanded polyurethane, CFC free
 Safe-finger interlocking system preventing any trapping episodes during door's moving cycle
 EPDM rubber seal grooved into the panel's top
 Reinforced panel's structure with galvanized steel strips in top and bottom ends of the panel
 Great thermal and acoustic insulation

Outer appearance:

0,4mm galvanized steel plate, pre-powdercoated and with anti-corrosion treatment
 Smooth texture

Inner appearance:

0,4mm galvanized steel plate, pre-powdercoated and with anti-corrosion treatment
 Thin ribbed pattern and 'stucco' emboss, pre-powdercoated white RAL 9010

Minimum charge: 5 m²

LM LISO LISO

LISO LISO | LISSE LISSE | SUPER FLAT



Painel Standard Panel Estándar Panneau Standard Standard Panel			

PS.040CA20	Branco Blanco Blanc White	RAL9010	m ²
PS.040CA22	Cinza Gris Gris Grey	RAL7016	m ²
PS.040CA23	Imitação de madeira clara Imitación de madera clara Imitation bois clair Light timber coated design	Uma face Una cara Une face One-side	m ²
PS.040CA24	Imitação de madeira escura Imitación de madera oscura Imitation bois foncé Dark timber coated design	Uma face Una cara Une face One-side	m ²

Pintura a pedido Pintura por pedido Peinture sur demande Painted on demand			

PS.040CA89	Catálogo RAL (1 face) Carta RAL (1 cara) Nuancier RAL (1 face) RAL colour chart (1 side)		m ²
PS.040CA88	Afinação por amostra (1 face) Afinación por muestra (1 cara) Afination par échantillon (1 face) Sampled colour (1 side)		m ²

Painel Standard Panel Estándar Panneau Standard Standard Panel			

PL.040CA20	Branco Blanco Blanc White	RAL9010	m ²
PL.040CA22	Cinza Gris Gris Grey	RAL7016	m ²
PL.040CA23	Imitação de madeira clara Imitación de madera clara Imitation bois clair Light timber coated design	Uma face Una cara Une face One-side	m ²
PL.040CA24	Imitação de madeira escura Imitación de madera oscura Imitation bois foncé Dark timber coated design	Uma face Una cara Une face One-side	m ²

Pintura a pedido Pintura por pedido Peinture sur demande Painted on demand			

PL.040CA89	Catálogo RAL (1 face) Carta RAL (1 cara) Nuancier RAL (1 face) RAL colour chart (1 side)		m ²
PL.040CA88	Afinação por amostra (1 face) Afinación por muestra (1 cara) Afination par échantillon (1 face) Sampled colour (1 side)		m ²

PT Painel sandwich

Em secções de 500mm ou 610mm de altura útil e espessura de 40mm
 Interior em poliuretano expandido de alta densidade e isento de CFC's
 Encaixe anti-dedo prevenindo qualquer hipótese de entalamento durante a operação do portão
 Vedante em EPDM embutido no macho do painel
 Chapas de reforço em aço galvanizado, inferior e superior, no interior do painel
 Grande isolamento térmico e acústico

Cara exterior

Chapa de aço de 0,7mm pré-lacada e com tratamento anti-oxidação
 Textura Lisa

Cara interior

Chapa de aço de 0,4mm pré-lacada e com tratamento anti-oxidação
 Canelado fino e textura 'stucco', branco RAL 9010

Faturação mínima: 5 m²

ES Panel sandwich

Con secciones de 500mm o 610mm de altura útil y espesor de 40mm
 Interior de poliuretano expandido de gran densidad y libre de CFC
 Encaje antipinzamiento preveniendo cualquier situación de riesgo durante su movimentación
 Goma de EPDM incrustada en el macho del panel
 Área de refuerzo, inferior y superior, de acero galvanizado, en el interior del panel
 Gran aislamiento térmico y acústico

Cara exterior

Chapa de acero 0,7mm prelacada y con tratamiento antioxidación
 Textura Lisa

Cara interior

Chapa lisa de acero de 0,4mm prelacada y con tratamiento antioxidación
 Acanalado fino y textura 'stucco', blanco RAL 9010

Facturación mínima: 5 m²

**FR Panneau sandwich**

En section de 500mm ou 610mm de hauteur utile et épaisseur de 40mm
 Intérieur en polyuréthane à haute densité et dépourvu de CFC
 Emboîtement anti-pince doigt, évitant toute possibilité de coincement pendant la marche de la porte
 Plaques de renfort en acier galvanisé, inférieures et supérieures, à l'intérieur du panneau
 Joint EPDM encastré dans la partie mâle du panneau
 Forte isolation thermique et acoustique

Coté extérieur

Tôle d'acier de 0,7mm pré-laqué et avec traitement antioxydant
 Texture lisse

Coté intérieur:

Tôle d'acier de 0,4mm pré-laqué et avec traitement antioxydant
 Rainuré fin et texture 'stucco', blanc Ral 9010

Minimum de facturation: 5 m²

EN Sandwich panel

In sections of 500mm or 610mm height and thickness of 40mm
 Interior of high density expanded polyurethane, CFC free
 Safe-finger interlocking system preventing any trapping episodes during door's moving cycle
 EPDM rubber seal grooved into the panel's top
 Reinforced panel's structure with galvanized steel strips in top and bottom ends of the panel
 Great thermal and acoustic insulation

Outer appearance:

0,7mm galvanized steel plate, pre-powdercoated and with anti-corrosion treatment
 Smooth texture

Inner appearance:

0,4mm galvanized steel plate, pre-powdercoated and with anti-corrosion treatment
 Thin ribbed pattern and 'stucco' emboss, pre-powdercoated white RAL 9010

Minimum charge: 5 m²

LM MICRO-FRISO LISO

MICROACANALADO LISO | MICRONEVURÉ LISSE | MICRO RIBBED



Painel Standard Panel Estándar Panneau Standard Standard Panel	
---	--

PS.040MA00	Branco Blanco Blanc White	RAL9010	m ²
------------	------------------------------------	---------	----------------

Pintura a pedido Pintura por pedido Peinture sur demande Painted on demand	
---	--

PS.040MA99	Catálogo RAL (1 face) Carta RAL (1 cara) Nuancier RAL (1 face) RAL colour chart (1 side)		m ²
------------	---	--	----------------

PS.040MA98	Afinação por amostra (1 face) Afinación por muestra (1 cara) Afination par échantillon (1 face) Sampled colour (1 side)		m ²
------------	--	--	----------------

Painel Standard Panel Estándar Panneau Standard Standard Panel	
---	--

PL.040MA00	Branco Blanco Blanc White	RAL9010	m ²
------------	------------------------------------	---------	----------------

Pintura a pedido Pintura por pedido Peinture sur demande Painted on demand	
---	--

PL.040MA99	Catálogo RAL (1 face) Carta RAL (1 cara) Nuancier RAL (1 face) RAL colour chart (1 side)		m ²
------------	---	--	----------------

PL.040MA98	Afinação por amostra (1 face) Afinación por muestra (1 cara) Afination par échantillon (1 face) Sampled colour (1 side)		m ²
------------	--	--	----------------



PT Painel sandwich

Em secções de 500mm ou 610mm de altura útil e espessura de 40mm
Interior em poliuretano expandido de alta densidade e isento de CFC
Encaixe anti-dedo prevenindo qualquer hipótese de entalamento durante a operação do portão
Vedante em EPDM embutido no macho do painel
Chapas de reforço em aço galvanizado, inferior e superior, no interior do painel
Grande isolamento térmico e acústico

Cara exterior

Chapa de aço de 0,4mm pré-lacada e com tratamento anti-oxidação
Micro-friso e textura lisa

Cara interior

Chapa de aço de 0,4mm pré-lacada e com tratamento anti-oxidação
Canelado fino e textura 'stucco', branco RAL 9010

Faturação mínima: 5 m²

ES Panel sandwich

Con secciones de 500mm o 610mm de altura útil y espesor de 40mm
Interior de poliuretano expandido de gran densidad y libre de CFC
Encaje antipinzamiento preveniendo cualquier situación de riesgo durante su movimentación
Goma de EPDM incrustada en el macho del panel
Área de refuerzo, inferior y superior, de acero galvanizado, en el interior del panel
Gran aislamiento térmico y acústico

Cara exterior

Chapa de acero 0,4mm prelacada y con tratamiento antioxidación
Microacanelado y textura lisa

Cara interior

Chapa lisa de acero de 0,4mm prelacada y con tratamiento antioxidación
Acanalado fino y textura 'stucco', blanco RAL 9010

Facturación mínima: 5 m²

**FR Panneau sandwich**

En section de 500mm ou 610mm de hauteur utile et épaisseur de 40mm
 Intérieur en polyuréthane à haute densité et dépourvu de CFC
 Emboîtement anti-pince doigt, évitant toute possibilité de coincement pendant la marche de la porte
 Plaques de renfort en acier galvanisé, inférieures et supérieures, à l'intérieur du panneau
 Joint EPDM encastré dans la partie mâle du panneau
 Forte isolation thermique et acoustique

Coté extérieur

Tôle d'acier de 0,4mm pré-laqué et avec traitement antioxydant
 Micronervuré et texture lisse

Coté intérieur:

Tôle d'acier de 0,4mm pré-laqué et avec traitement antioxydant
 Rainuré fin et texture 'stucco', blanc RAL 9010

Minimum de facturation: 5 m²

EN Sandwich panel

In sections of 500mm or 610mm height and thickness of 40mm
 Interior of high density expanded polyurethane, CFC free
 Safe-finger interlocking system preventing any trapping episodes during door's moving cycle
 EPDM rubber seal grooved into the panel's top
 Reinforced panel's structure with galvanized steel strips in top and bottom ends of the panel
 Great thermal and acoustic insulation

Outer appearance:

0,4mm galvanized steel plate, pre-powdercoated and with anti-corrosion treatment
 Micro ribbed and smooth texture

Inner appearance:

0,4mm galvanized steel plate, pre-powdercoated and with anti-corrosion treatment
 Thin ribbed pattern and 'stucco' emboss, pre-powdercoated white RAL 9010

Minimum charge: 5 m²

LM FRISO ÚNICO LISO

UNICANELADO LISO | MONO LIGNE LISSE | CENTRE RIBBED SUPER FLAT



Painel Standard Panel Estándar Panneau Standard Standard Panel			

PS.040CA30	Branco Blanco Blanc White	RAL9010	m ²
PS.040CA33	Imitação de madeira clara Imitación de madera clara Imitation bois clair Light timber coated design	Uma face Una cara Une face One-side	m ²
PS.040CA34	Imitação de madeira escura Imitación de madera oscura Imitation bois foncé Dark timber coated design	Uma face Una cara Une face One-side	m ²
PS.040CA76	Imitação de madeira clara Imitación de madera clara Imitation bois clair Light timber coated design	Duas faces Dos caras Deux faces Two-sided	m ²
PS.040CA77	Imitação de madeira escura Imitación de madera oscura Imitation bois foncé Dark timber coated design	Duas faces Dos caras Deux faces Two-sided	m ²

Pintura a pedido Pintura por pedido Peinture sur demande Painted on demand			

PS.040CA79	Catálogo RAL (1 face) Carta RAL (1 cara) Nuancier RAL (1 face) RAL colour chart (1 side)		m ²
PS.040CA78	Afinação por amostra (1 face) Afinación por muestra (1 cara) Afination par échantillon (1 face) Sampled colour (1 side)		m ²

Painel Standard Panel Estándar Panneau Standard Standard Panel			

PL.040CA30	Branco Blanco Blanc White	RAL9010	m ²
PL.040CA33	Imitação de madeira clara Imitación de madera clara Imitation bois clair Light timber coated design	Uma face Una cara Une face One-side	m ²
PL.040CA34	Imitação de madeira escura Imitación de madera oscura Imitation bois foncé Dark timber coated design	Uma face Una cara Une face One-side	m ²
PL.040CA76	Imitação de madeira clara Imitación de madera clara Imitation bois clair Light timber coated design	Duas faces Dos caras Deux faces Two-sided	m ²
PL.040CA77	Imitação de madeira escura Imitación de madera oscura Imitation bois foncé Dark timber coated design	Duas faces Dos caras Deux faces Two-sided	m ²

Pintura a pedido Pintura por pedido Peinture sur demande Painted on demand			

PL.040CA79	Catálogo RAL (1 face) Carta RAL (1 cara) Nuancier RAL (1 face) RAL colour chart (1 side)		m ²
PL.040CA78	Afinação por amostra (1 face) Afinación por muestra (1 cara) Afination par échantillon (1 face) Sampled colour (1 side)		m ²

PT Painel sandwich

Em secções de 500mm de altura útil e espessura de 40mm
 Interior em poliuretano expandido de alta densidade e isento de CFC
 Encaixe anti-dedo prevenindo qualquer hipótese de entalamento durante a operação do portão
 Vedante em EPDM embutido no macho do painel
 Chapas de reforço em aço galvanizado, inferior e superior, no interior do painel
 Grande isolamento térmico e acústico

Cara exterior

Chapa de aço de 0,4mm pré-lacada e com tratamento anti-oxidação
 Unicanal largo e textura lisa

Cara interior

Chapa de aço de 0,4mm pré-lacada e com tratamento anti-oxidação
 Canelado fino e textura 'stucco', branco RAL 9010

Faturação mínima: 5 m²

ES Panel sandwich

Con secciones de 500mm de altura útil y espesor de 40mm
 Interior de poliuretano expandido de gran densidad y libre de CFC
 Encaje antipinzamiento preveniendo cualquier situación de riesgo durante su movimentación
 Goma de EPDM incrustada en el macho del panel
 Área de refuerzo, inferior y superior, de acero galvanizado, en el interior del panel
 Gran aislamiento térmico y acústico

Cara exterior

Chapa de acero 0,4mm prelacada y con tratamiento antioxidación
 Uniacanelado fino y textura lisa

Cara interior

Chapa liso de acero de 0,4mm prelacada y con tratamiento antioxidación
 Acanalado fino y textura 'stucco', blanco RAL 9010

Facturación mínima: 5 m²

**FR Panneau sandwich**

En section de 500mm de hauteur utile et épaisseur de 40mm
 Intérieur en polyuréthane à haute densité et dépourvu de CFC
 Emboîtement anti-pince doigt, évitant toute possibilité de coincement pendant la marche de la porte
 Plaques de renfort en acier galvanisé, inférieures et supérieures, à l'intérieur du panneau
 Joint EPDM encastré dans la partie mâle du panneau
 Forte isolation thermique et acoustique

Coté extérieur

Tôle d'acier de 0,4mm pré-laqué et avec traitement antioxydant
 Mono ligne large et texture lisse

Coté intérieur:

Tôle d'acier de 0,4mm pré-laqué et avec traitement antioxydant
 Rainuré fin et texture 'stucco', blanc RAL 9010

Minimum de facturation: 5 m²

EN Sandwich panel

In sections of 500mm height and thickness of 40mm
 Interior of high density expanded polyurethane, CFC free
 Safe-finger interlocking system preventing any trapping episodes during door's moving cycle
 EPDM rubber seal grooved into the panel's top
 Reinforced panel's structure with galvanized steel strips in top and bottom ends of the panel
 Great thermal and acoustic insulation

Outer appearance:

0,4mm galvanized steel plate, pre-powdercoated and with anti-corrosion treatment
 Wide center-ribbed and smooth texture

Inner appearance:

0,4mm galvanized steel plate, pre-powdercoated and with anti-corrosion treatment
 Thin ribbed pattern and 'stucco' emboss, pre-powdercoated white RAL 9010

Minimum charge: 5 m²

LM FRISO ÚNICO WOODGRAIN

UNICANELADO WOODGRAIN | MONO LIGNE WOODGRAIN | CENTRE RIBBED WOODGRAIN



Painel Standard Panel Estándar Panneau Standard Standard Panel	
---	--

PS.040CA40	Branco Blanco Blanc White	RAL9010	m ²
------------	------------------------------------	---------	----------------

Pintura a pedido Pintura por pedido Peinture sur demande Painted on demand	
---	--

PS.040CA49	Catálogo RAL (1 face) Carta RAL (1 cara) Nuancier RAL (1 face) RAL colour chart (1 side)	m ²
------------	---	----------------

PS.040CA48	Afinação por amostra (1 face) Afinación por muestra (1 cara) Afination par échantillon (1 face) Sampled colour (1 side)	m ²
------------	--	----------------

Painel Standard Panel Estándar Panneau Standard Standard Panel	
---	--

PL.040CA40	Branco Blanco Blanc White	RAL9010	m ²
------------	------------------------------------	---------	----------------

Pintura a pedido Pintura por pedido Peinture sur demande Painted on demand	
---	--

PL.040CA49	Catálogo RAL (1 face) Carta RAL (1 cara) Nuancier RAL (1 face) RAL colour chart (1 side)	m ²
------------	---	----------------

PL.040CA48	Afinação por amostra (1 face) Afinación por muestra (1 cara) Afination par échantillon (1 face) Sampled colour (1 side)	m ²
------------	--	----------------



PT Painel sandwich

Em secções de 500mm de altura útil e espessura de 40mm
Interior em poliuretano expandido de alta densidade e isento de CFC
Encaixe anti-dedo prevenindo qualquer hipótese de entalamento durante a operação do portão
Vedante em EPDM embutido no macho do painel
Chapas de reforço em aço galvanizado, inferior e superior, no interior do painel
Grande isolamento térmico e acústico

Cara exterior

Chapa de aço de 0,7mm pré-lacada e com tratamento anti-oxidação
Unicanal largo e textura woodgrain

Cara interior

Chapa de aço de 0,4mm pré-lacada e com tratamento anti-oxidação
Canelado fino e textura 'stucco', branco Ral 9010

Faturação mínima: 5 m²

ES Panel sandwich

Con secciones de 500mm de altura útil y espesor de 40mm
Interior de poliuretano expandido de gran densidad y libre de CFC
Encaje antipinzamiento preveniendo cualquier situación de riesgo durante su movimentación
Goma de EPDM incrustada en el macho del panel
Área de refuerzo, inferior y superior, de acero galvanizado, en el interior del panel
Gran aislamiento térmico y acústico

Cara exterior

Chapa de acero 0,7mm prelacada y con tratamiento antioxidación
Unicanalado largo y textura woodgrain

Cara interior

Chapa liso de acero de 0,4mm prelacada y con tratamiento antioxidación
Acanalado fino y textura 'stucco', blanco RAL 9010

Facturación mínima: 5 m²

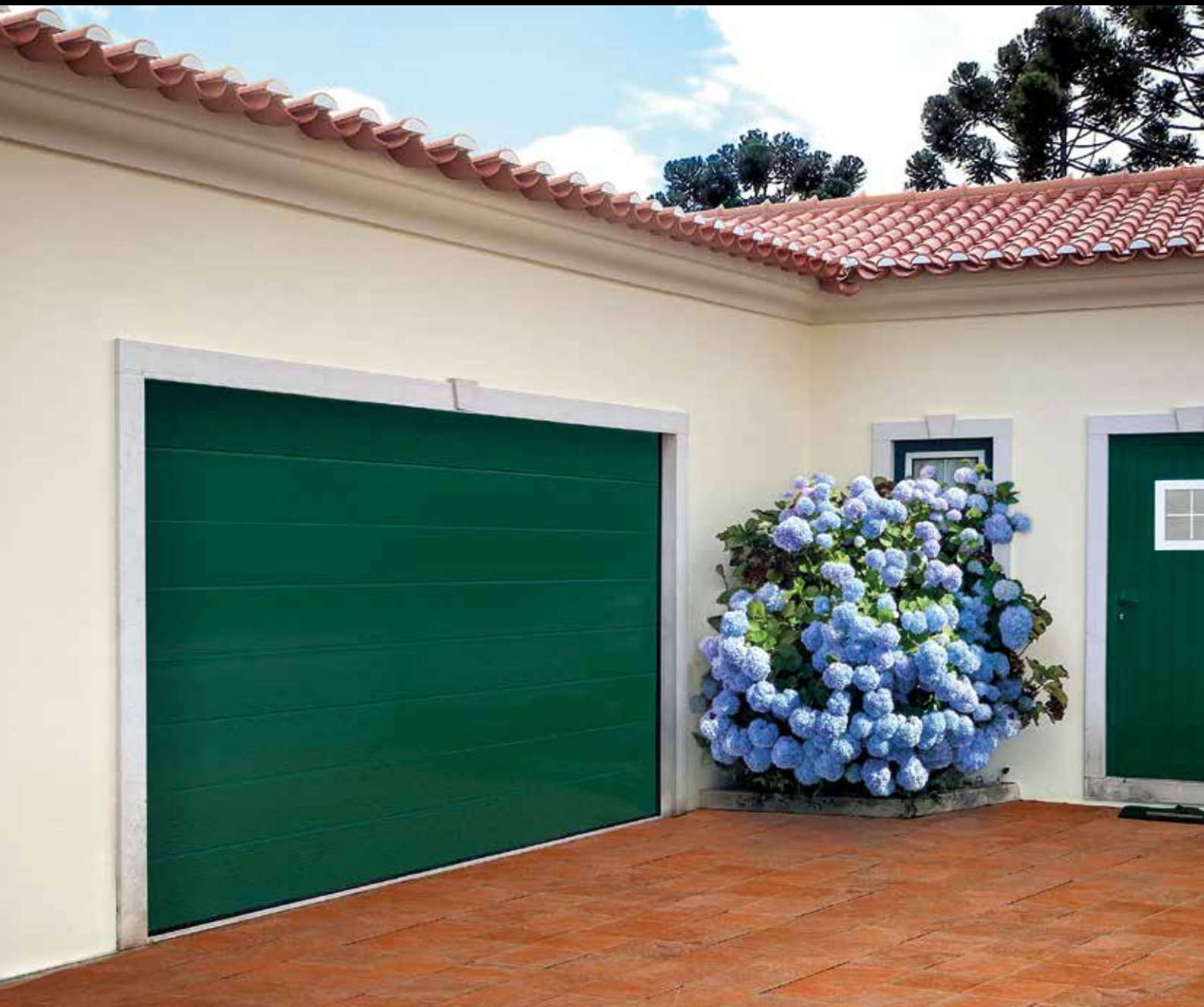
**FR Panneau sandwich**

En section de 500mm de hauteur utile et épaisseur de 40mm
 Intérieur en polyuréthane à haute densité et dépourvu de CFC
 Emboîtement anti-pince doigt, évitant toute possibilité de coincement pendant la marche de la porte
 Plaques de renfort en acier galvanisé, inférieures et supérieures, à l'intérieur du panneau
 Joint EPDM encastré dans la partie mâle du panneau
 Forte isolation thermique et acoustique

Coté extérieur

Tôle d'acier de 0,7mm pré-laqué et avec traitement antioxydant
 Mono ligne large et texture woodgrain

Coté intérieur:

Tôle d'acier de 0,4mm pré-laqué et avec traitement antioxydant
 Rainuré fin et texture 'stucco', blanc RAL 9010

Minimum de facturation: 5 m²

EN Sandwich panel

In sections of 500mm height and thickness of 40mm
 Interior of high density expanded polyurethane, CFC free
 Safe-finger interlocking system preventing any trapping episodes during door's moving cycle
 EPDM rubber seal grooved into the panel's top
 Reinforced panel's structure with galvanized steel strips in top and bottom ends of the panel
 Great thermal and acoustic insulation

Outer appearance:

0,7mm galvanized steel plate, pre-powdercoated and with anti-corrosion treatment
 Wide center-ribbed and woodgrain texture

Inner appearance:

0,4mm galvanized steel plate, pre-powdercoated and with anti-corrosion treatment
 Thin ribbed pattern and 'stucco' emboss, pre-powdercoated white RAL 9010

Minimum charge: 5 m²

LM CANELADO WOODGRAIN

ACANELADO WOODGRAIN | RAINURÉ WOODGRAIN | RIBBED WOODGRAIN



Aço galvanizado | Pré-lacado
Acero galvanizado | Prelacado
Acier galvanisé | Pré-laqué
Galvanized steel | Precoated



PS.040CA00	Branco Blanco Blanc White	RAL 9010	m ²
PS.040CA06	Crema Crema Beige Cream	RAL 1015	m ²
PS.040CA07	Cinza	RAL 9006	m ²
PS.040CA15	Gris	RAL 9007	
PS.040CA11	Gris	RAL 7011	
PS.040CA12	Grey	RAL 7016	
PS.040CA01	Verde	RAL 6005	m ²
PS.040CA10	Vert Green	RAL 6009	
PS.040CA02	Castanho Marrón Marron Brown	RAL 8014	m ²
PS.040CA08	Azul Azul Bleu Blue	RAL 5010	m ²
PS.040CA09	Vermelho Rojo Rouge Red	RAL 3000	m ²

Aço galvanizado | Pintura a pedido
Acero galvanizado | Pintura por pedido
Acier galvanisé | Peinture sur demande
Galvanized steel | Painted on demand



PS.040CA99	Catálogo RAL (1 face) Carta RAL (1 cara) Nuancier RAL (1 face) RAL colour chart (1 side)		m ²
PS.040CA98	Afinação por amostra (1 face) Afinación por muestra (1 cara) Afination par échantillon (1 face) Sampled colour (1 side)		m ²

Aço galvanizado | Pré-lacado
Acero galvanizado | Prelacado
Acier galvanisé | Pré-laqué
Galvanized steel | Precoated



PL.040CA00	Branco Blanco Blanc White	RAL 9010	m ²
PL.040CA06	Crema Crema Beige Cream	RAL 1015	m ²
PL.040CA07	Cinza	RAL 9006	m ²
PL.040CA15	Gris	RAL 9007	
PL.040CA11	Gris	RAL 7011	
PL.040CA12	Grey	RAL 7016	
PL.040CA01	Verde	RAL 6005	m ²
PL.040CA10	Vert Green	RAL 6009	
PL.040CA02	Castanho Marrón Marron Brown	RAL 8014	m ²
PL.040CA08	Azul Azul Bleu Blue	RAL 5010	m ²
PL.040CA09	Vermelho Rojo Rouge Red	RAL 3000	m ²

Aço galvanizado | Pintura a pedido
Acero galvanizado | Pintura por pedido
Acier galvanisé | Peinture sur demande
Galvanized steel | Painted on demand



PL.040CA99	Catálogo RAL (1 face) Carta RAL (1 cara) Nuancier RAL (1 face) RAL colour chart (1 side)		m ²
PL.040CA98	Afinação por amostra (1 face) Afinación por muestra (1 cara) Afination par échantillon (1 face) Sampled colour (1 side)		m ²

PT Painel sandwich

Em secções de 500mm ou 610mm de altura útil e espessura de 40mm
Interior em poliuretano expandido de alta densidade e isento de CFC
Encaixe anti-dedo prevenindo qualquer hipótese de entalamento durante a operação do portão
Vedante em EPDM embutido no macho do painel
Chapas de reforço em aço galvanizado, inferior e superior, no interior do painel
Grande isolamento térmico e acústico

Cara exterior

Chapa de aço de 0,4mm pré-lacada e com tratamento anti-oxidação
Canelado fino e textura woodgrain

Cara interior

Chapa de aço de 0,4mm pré-lacada e com tratamento anti-oxidação
Canelado fino e textura 'stucco', branco RAL 9010

Faturação mínima: 5 m²

ES Panel sandwich

Con secciones de 500mm o 610mm de altura útil y espesor de 40mm
Interior de poliuretano expandido de gran densidad y libre de CFC
Encaje antipinzamiento preveniendo cualquier situación de riesgo durante su movimentación
Goma de EPDM incrustada en el macho del panel
Área de refuerzo, inferior y superior, de acero galvanizado, en el interior del panel
Gran aislamiento térmico y acústico

Cara exterior

Chapa de acero 0,4mm prelacada y con tratamiento antioxidación
Acanelado fino y textura woodgrain

Cara interior

Chapa lisa de acero de 0,4mm prelacada y con tratamiento antioxidación
Acanalado fino y textura 'stucco', blanco RAL 9010

Facturación mínima: 5 m²

**FR Panneau sandwich**

En section de 500mm ou 610mm de hauteur utile et épaisseur de 40mm
 Intérieur en polyuréthane à haute densité et dépourvu de CFC
 Emboîtement anti-pince doigt, évitant toute possibilité de coincement pendant la marche de la porte
 Plaques de renfort en acier galvanisé, inférieures et supérieures, à l'intérieur du panneau
 Joint EPDM encastré dans la partie mâle du panneau
 Forte isolation thermique et acoustique

Coté extérieur

Tôle d'acier de 0,4mm pré-laqué et avec traitement antioxydant
 Rainuré fin et texture woodgrain

Coté intérieur:

Tôle d'acier de 0,4mm pré-laqué et avec traitement antioxydant
 Rainuré fin et texture 'stucco', blanc RAL 9010

Minimum de facturation: 5 m²

EN Sandwich panel

In sections of 500mm or 610mm height and thickness of 40mm
 Interior of high density expanded polyurethane, CFC free
 Safe-finger interlocking system preventing any trapping episodes during door's moving cycle
 EPDM rubber seal grooved into the panel's top
 Reinforced panel's structure with galvanized steel strips in top and bottom ends of the panel
 Great thermal and acoustic insulation

Outer appearance:

0,4mm galvanized steel plate, pre-powdercoated and with anti-corrosion treatment
 Thin ribbed and woodgrain texture

Inner appearance:

0,4mm galvanized steel plate, pre-powdercoated and with anti-corrosion treatment
 Thin ribbed pattern and 'stucco' emboss, pre-powdercoated white RAL 9010

Minimum charge: 5 m²

LM CANELADO LISO

ACANELADO LISO / RAINURÉ LISSE / RIBBED SUPER FLAT



Painel Standard Panel Estándar Panneau Standard Standard Panel	
---	--

PS.040CA13	Imitação de madeira clara Imitación de madera clara Imitation bois clair Light timber coated design	Uma face Una cara Une face One-side	m ²
PS.040CA14	Imitação de madeira escura Imitación de madera oscura Imitation bois foncé Dark timber coated design	Uma face Una cara Une face One-side	m ²
PS.040CA73	Imitação de madeira clara Imitación de madera clara Imitation bois clair Light timber coated design	Duas faces Dos caras Deux faces Two-sided	m ²
PS.040CA74	Imitação de madeira escura Imitación de madera oscura Imitation bois foncé Dark timber coated design	Duas faces Dos caras Deux faces Two-sided	m ²

Painel Standard Panel Estándar Panneau Standard Standard Panel	
---	--

PL.040CA13	Imitação de madeira clara Imitación de madera clara Imitation bois clair Light timber coated design	Uma face Una cara Une face One-side	m ²
PL.040CA14	Imitação de madeira escura Imitación de madera oscura Imitation bois foncé Dark timber coated design	Uma face Una cara Une face One-side	m ²
PL.040CA73	Imitação de madeira clara Imitación de madera clara Imitation bois clair Light timber coated design	Duas faces Dos caras Deux faces Two-sided	m ²
PL.040CA74	Imitação de madeira escura Imitación de madera oscura Imitation bois foncé Dark timber coated design	Duas faces Dos caras Deux faces Two-sided	m ²



PT Painel sandwich

Em secções de 500mm ou 610mm de altura útil e espessura de 40mm
Interior em poliuretano expandido de alta densidade e isento de CFC
Encaixe anti-dedo prevenindo qualquer hipótese de entalamento durante a operação do portão
Vedante em EPDM embutido no macho do painel
Chapas de reforço em aço galvanizado, inferior e superior, no interior do painel
Grande isolamento térmico e acústico

Cara exterior

Chapa de aço de 0,4mm pré-lacada e com tratamento anti-oxidação
Canelado fino e textura lisa

Cara interior

Chapa de aço de 0,4mm pré-lacada e com tratamento anti-oxidação
Canelado fino e textura 'stucco', branco RAL 9010

Faturação mínima: 5 m²

ES Panel sandwich

Con secciones de 500mm o 610mm de altura útil y espesor de 40mm
Interior de poliuretano expandido de gran densidad y libre de CFC
Encaje antipinzamiento preveniendo cualquier situación de riesgo durante su movimentación
Goma de EPDM incrustada en el macho del panel
Área de refuerzo, inferior y superior, de acero galvanizado, en el interior del panel
Gran aislamiento térmico y acústico

Cara exterior

Chapa de acero 0,4mm prelacada y con tratamiento antioxidación
Acanelado fino y textura lisa

Cara interior

Chapa liso de acero de 0,4mm prelacada y con tratamiento antioxidación
Acanalado fino y textura 'stucco', blanco RAL 9010

Facturación mínima: 5 m²

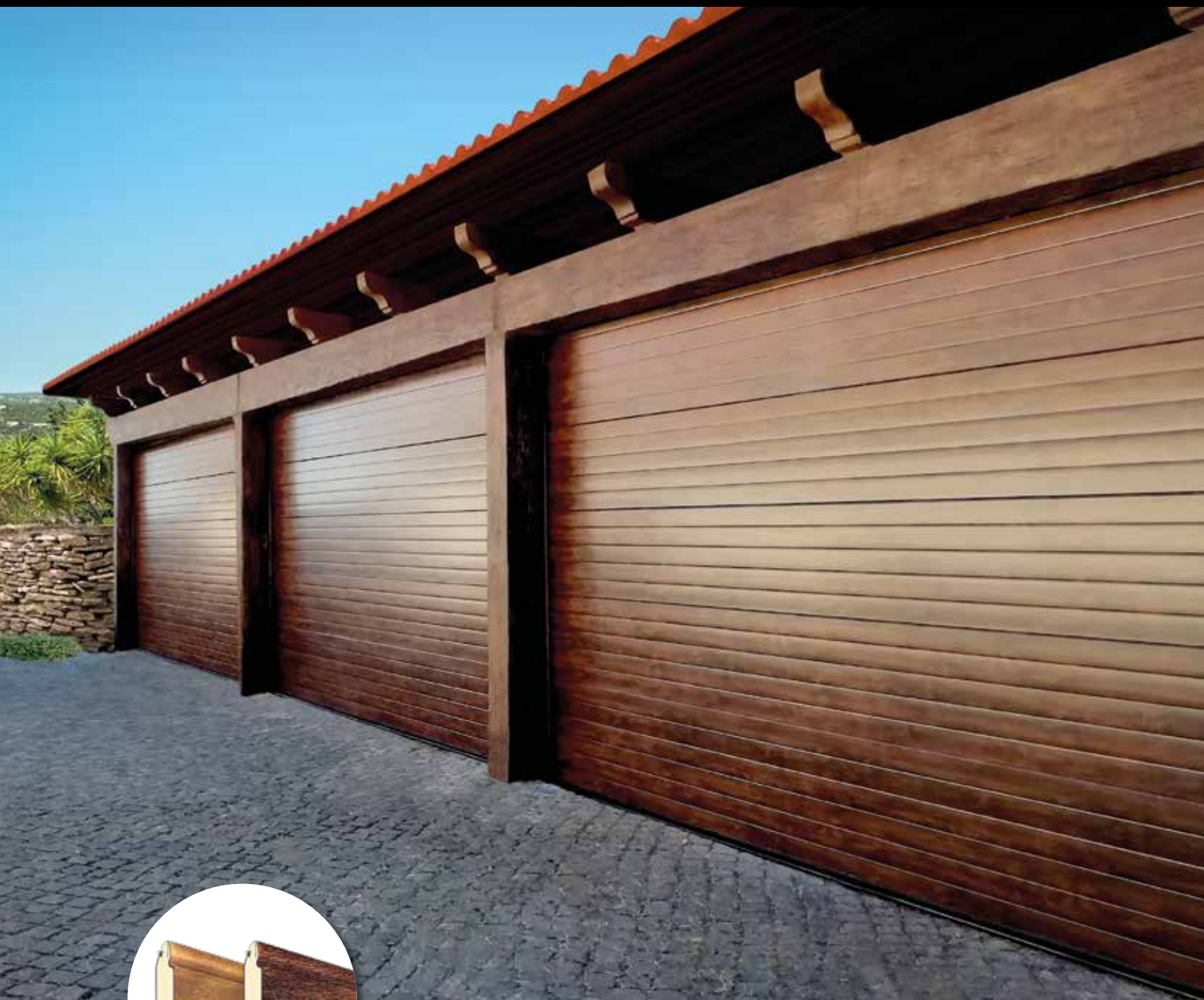

FR Panneau sandwich

En section de 500mm ou 610mm de hauteur utile et épaisseur de 40mm
 Intérieur en polyuréthane à haute densité et dépourvu de CFC
 Emboîtement anti-pince doigt, évitant toute possibilité de coincement pendant la marche de la porte
 Plaques de renfort en acier galvanisé, inférieures et supérieures, à l'intérieur du panneau
 Joint EPDM encastré dans la partie mâle du panneau
 Forte isolation thermique et acoustique

Coté extérieur

Tôle d'acier de 0,4mm pré-laqué et avec traitement antioxydant
 Rainuré fin et texture lisse

Coté intérieur:

Tôle d'acier de 0,4mm pré-laqué et avec traitement antioxydant
 Rainuré fin et texture 'stucco', blanc RAL 9010

Minimum de facturation: 5 m²

EN Sandwich panel

In sections of 500mm or 610mm height and thickness of 40mm
 Interior of high density expanded polyurethane, CFC free
 Safe-finger interlocking system preventing any trapping episodes during door's moving cycle
 EPDM rubber seal grooved into the panel's top
 Reinforced panel's structure with galvanized steel strips in top and bottom ends of the panel
 Great thermal and acustic insulation

Outer appearance:

0,4mm galvanized steel plate, pre-powdercoated and with anti-corrosion treatment
 Thin ribbed and smooth texture

Inner appearance:

0,4mm galvanized steel plate, pre-powdercoated and with anti-corrosion treatment
 Thin ribbed pattern and 'stucco' emboss, pre-powdercoated white RAL 9010

Minimum charge: 5 m²

LM ALMOFADADO WOODGRAIN



CUARTERONES WOODGRAIN / CASSETTE WOODGRAIN / PANELLED WOODGRAIN

Painel Standard Panel Estándar Panneau Standard Standard Panel	
---	--

PS.040AA00	Branco Blanco Blanc White	RAL9010	m ²
PS.040AA03	Imitação de madeira clara Imitación de madera clara Imitation bois clair Light timber coated design		m ²
PS.040AA04	Imitação de madeira escura Imitación de madera oscura Imitation bois foncé Dark timber coated design		m ²

Pintura a pedido Pintura por pedido Peinture sur demande Painted on demand	
---	--

PS.040AA99	Catálogo RAL (1 face) Carta RAL (1 cara) Nuancier RAL (1 face) RAL colour chart (1 side)		m ²
PS.040AA98	Afinação por amostra (1 face) Afinación por muestra (1 cara) Afinación par échantillon (1 face) Sampled colour (1 side)		m ²

Painel Standard Panel Estándar Panneau Standard Standard Panel	
---	--

PL.040AA00	Branco Blanco Blanc White	RAL9010	m ²
PL.040AA03	Imitação de madeira clara Imitación de madera clara Imitation bois clair Light timber coated design		m ²
PL.040AA04	Imitação de madeira escura Imitación de madera oscura Imitation bois foncé Dark timber coated design		m ²

Pintura a pedido Pintura por pedido Peinture sur demande Painted on demand	
---	--

PL.040CA49	Catálogo RAL (1 face) Carta RAL (1 cara) Nuancier RAL (1 face) RAL colour chart (1 side)		m ²
PL.040CA48	Afinação por amostra (1 face) Afinación por muestra (1 cara) Afinación par échantillon (1 face) Sampled colour (1 side)		m ²

Medidas p/ Facturação Medidas p/ Faturación Dimensions p/ Facturation Billing Dimension	2450	2750	3050	3350	3650	4050	4350	4850	5150	5250	5950	6750	7400	7600	8100	8400
Número de Almofadas Número de Cuarterones Número de Cassettes Number of Panels	3	3	4	4	5	5	5	6	6	7	7	8	10	9	11	10
Espaço entre Almofadas Espaciamento Cuarterones Espacement des Cassettes Interpanel Space	210	300	210	210	210	210	300	210	300	210	300	300	210	300	210	300
Tamanho Mínimo (panel) Tamaño Mínimo (panel) Taille Minimum (panneau) Minimum Size (panel)	2001	2181	2718	2718	3435	3435	3795	4152	4602	4869	5409	6216	7020	7023	7737	7830
Tamanho Máximo (panel) Tamaño Máximo (panel) Taille Maximale (panneau) Maximum Size (panel)	2410	2710	3010	3310	3610	4010	4310	4810	5102	5189	5909	6716	7340	7523	8000	8000

PT Painel sandwich

Em secções de 500mm ou 610mm de altura útil e espessura de 40mm
Interior em poliuretano expandido de alta densidade e isento de CFC
Encaixe anti-dedo prevenindo qualquer hipótese de entalamento durante a operação do portão
Vedante em EPDM embutido no macho do painel
Chapas de reforço em aço galvanizado, inferior e superior, no interior do painel
Grande isolamento térmico e acústico

Cara exterior

Chapa de aço de 0,4mm pré-lacada e com tratamento anti-oxidação
Almofadado e textura woodgrain

Cara interior

Chapa de aço de 0,4mm pré-lacada e com tratamento anti-oxidação
Canelado fino e textura 'stucco', branco RAL 9010

Faturação mínima: 5 m²

ES Panel sandwich

Con secciones de 500mm o 610mm de altura útil y espesor de 40mm
Interior de poliuretano expandido de gran densidad y libre de CFC
Encaje antipinzamiento preveniendo cualquier situación de riesgo durante su movimentación
Goma de EPDM incrustada en el macho del panel
Área de refuerzo, inferior y superior, de acero galvanizado, en el interior del panel
Gran aislamiento térmico y acústico

Cara exterior

Chapa de acero 0,4mm prelacada y con tratamiento antioxidación
Cuarterones y textura woodgrain

Cara interior

Chapa lisa de acero de 0,4mm prelacada y con tratamiento antioxidación
Acanalado fino y textura 'stucco', blanco RAL 9010

Facturación mínima: 5 m²

**FR Panneau sandwich**

En section de 500mm ou 610mm de hauteur utile et épaisseur de 40mm
 Intérieur en polyuréthane à haute densité et dépourvu de CFC
 Emboîtement anti-pince doigt, évitant toute possibilité de coincement pendant la marche de la porte
 Plaques de renfort en acier galvanisé, inférieures et supérieures, à l'intérieur du panneau
 Joint EPDM encastré dans la partie mâle du panneau
 Forte isolation thermique et acoustique

Coté extérieur

Tôle d'acier de 0,4mm pré-laqué et avec traitement antioxydant
 Casette et texture woodgrain

Coté intérieur:

Tôle d'acier de 0,4mm pré-laqué et avec traitement antioxydant
 Rainuré fin et texture 'stucco', blanc RAL 9010

Minimum de facturation: 5 m²

EN Sandwich panel

In sections of 500mm or 610mm height and thickness of 40mm
 Interior of high density expanded polyurethane, CFC free
 Safe-finger interlocking system preventing any trapping episodes during door's moving cycle
 EPDM rubber seal grooved into the panel's top
 Reinforced panel's structure with galvanized steel strips in top and bottom ends of the panel
 Great thermal and acoustic insulation

Outer appearance:

0,4mm galvanized steel plate, pre-powdercoated and with anti-corrosion treatment
 Panelled and woodgrain texture

Inner appearance:

0,4mm galvanized steel plate, pre-powdercoated and with anti-corrosion treatment
 Thin ribbed pattern and 'stucco' emboss, pre-powdercoated white RAL 9010

Minimum charge: 5 m²

Alumínio, pré-lacado Aluminio, prelacado Aluminium, pré-laqué Aluminium, precoated	
---	--

PS.040CAA1	Branco Blanco Blanc White	RAL 9030	m ²
------------	------------------------------------	----------	----------------

Alumínio, pintura a pedido Aluminio, pintura por pedido Aluminium, peinture sur demande Aluminium, painted on demand	
---	--

PS.040CAA5	Catálogo RAL (1 face) Carta RAL (1 cara) Nuancier RAL (1 face) RAL colour chart (1 side)		m ²
------------	---	--	----------------

PS.040CAA4	Afinação por amostra (1 face) Afinación por muestra (1 cara) Afination par échantillon (1 face) Sampled colour (1 side)		m ²
------------	--	--	----------------

Alumínio, pré-lacado Aluminio, prelacado Aluminium, pré-laqué Aluminium, precoated	
---	--

PL.040CAA1	Branco Blanco Blanc White	RAL 9030	m ²
------------	------------------------------------	----------	----------------

Alumínio, pintura a pedido Aluminio, pintura por pedido Aluminium, peinture sur demande Aluminium, painted on demand	
---	--

PL.040CAA5	Catálogo RAL (1 face) Carta RAL (1 cara) Nuancier RAL (1 face) RAL colour chart (1 side)		m ²
------------	---	--	----------------

PL.040CAA4	Afinação por amostra (1 face) Afinación por muestra (1 cara) Afination par échantillon (1 face) Sampled colour (1 side)		m ²
------------	--	--	----------------



PT Painel sandwich

Em secções de 500mm de altura útil e espessura de 40mm

Interior em poliuretano expandido de alta densidade e isento de CFC

Encaixe anti-dedo prevenindo qualquer hipótese de entalamento durante a operação do portão

Vedante em EPDM embutido no macho do painel

Chapas de reforço em aço galvanizado, inferior e superior, no interior do painel

Grande isolamento térmico e acústico

Cara exterior

Chapa de alumínio de 0,6mm pré-lacada e com tratamento anti-oxidação

Unicanelado largo e textura lisa

Cara interior

Chapa de alumínio de 0,6mm pré-lacada e com tratamento anti-oxidação

Canelado fino e textura 'stucco', branco RAL 9030

Faturação mínima: 5 m²

ES Panel sandwich

Con secciones de 500mm de altura útil y espesor de 40mm

Interior de poliuretano expandido de gran densidad y libre de CFC

Encaje antipinzamiento preveniendo cualquier situación de riesgo durante su movimentación

Goma de EPDM incrustada en el macho del panel

Área de refuerzo, inferior y superior, de acero galvanizado, en el interior del panel

Gran aislamiento térmico y acústico

Cara exterior

Chapa de aluminio de 0,6mm prelacada con tratamiento antioxidación

Unicanelado largo y textura lisa

Cara interior

Chapa de aluminio de 0,6mm prelacada y con tratamiento antioxidación

Acanalado fino y textura 'stucco', blanco RAL 9030

Facturación mínima: 5 m²

**FR Panneau sandwich**

En section de 500mm de hauteur utile et épaisseur de 40mm
 Intérieur en polyuréthane à haute densité et dépourvu de CFC
 Emboîtement anti-pince doigt, évitant toute possibilité de coincement pendant la marche de la porte
 Plaques de renfort en acier galvanisé, inférieures et supérieures, à l'intérieur du panneau
 Joint EPDM encastré dans la partie mâle du panneau
 Forte isolation thermique et acoustique

Coté extérieur

Tôle d'aluminium lisse de 0,6mm pré-laqué et avec traitement antioxydant
 Mono ligne large et texture lisse

Coté intérieur:

Tôle d'aluminium de 0,6mm pré-laqué et avec traitement antioxydant
 Rainuré fin et texture 'stucco', blanc RAL 9030

Minimum de facturation: 5 m²

EN Sandwich panel

In sections of 500mm height and thickness of 40mm
 Interior of high density expanded polyurethane, CFC free
 Safe-finger interlocking system preventing any trapping episodes during door's moving cycle
 EPDM rubber seal grooved into the panel's top
 Reinforced panel's structure with galvanized steel strips in top and bottom ends of the panel
 Great thermal and acustic insulation

Outer appearance:

0,6mm aluminium plate, pre-powdercoated and with anti-corrosion treatment
 Wide center-ribbed and smoth texture

Inner appearance:

0,6mm aluminium plate, pre-powdercoated and with anti-corrosion treatment
 Thin ribbed pattern and 'stucco' emboss, pre-powdercoated white RAL 9030

Minimum charge: 5 m²

LM CANELADO ALUMÍNIO

ACANALADO ALUMINIO | RAINURÉ ALUMINIUM | RIBBED ALUMINIUM



Alumínio, pré-lacado Aluminio, prelacado Aluminium, pré-laqué Aluminium, precoated	
---	--

PS.040CAA0	Branco Blanco Blanc White	RAL9030	m ²
------------	------------------------------------	---------	----------------

Alumínio, pintura a pedido Aluminio, pintura por pedido Aluminium, peinture sur demande Aluminium, painted on demand	
---	--

PS.040CAA9	Catálogo RAL (1 face) Carta RAL (1 cara) Nuancier RAL (1 face) RAL colour chart (1 side)	m ²
------------	---	----------------

PS.040CAA8	Afinação por amostra (1 face) Afinación por muestra (1 cara) Afination par échantillon (1 face) Sampled colour (1 side)	m ²
------------	--	----------------

Alumínio, pré-lacado Aluminio, prelacado Aluminium, pré-laqué Aluminium, precoated	
---	--

PL.040CAA0	Branco Blanco Blanc White	RAL9030	m ²
------------	------------------------------------	---------	----------------

Alumínio, pintura a pedido Aluminio, pintura por pedido Aluminium, peinture sur demande Aluminium, painted on demand	
---	--

PL.040CAA9	Catálogo RAL (1 face) Carta RAL (1 cara) Nuancier RAL (1 face) RAL colour chart (1 side)	m ²
------------	---	----------------

PL.040CAA8	Afinação por amostra (1 face) Afinación por muestra (1 cara) Afination par échantillon (1 face) Sampled colour (1 side)	m ²
------------	--	----------------



PT Panel sandwich

Em secções de 500mm ou 610mm de altura útil e espessura de 40mm
Interior em poliuretano expandido de alta densidade e isento de CFC
Encaixe anti-dedo prevenindo qualquer hipótese de entalamento durante a operação do portão
Vedante em EPDM embutido no macho do painel
Chapas de reforço em aço galvanizado, inferior e superior, no interior do painel
Grande isolamento térmico e acústico

Cara exterior

Chapa de alumínio de 0,6mm pré-lacada e com tratamento anti-oxidação
Canelado largo e textura 'stucco'

Cara interior

Chapa de alumínio de 0,6mm pré-lacada e com tratamento anti-oxidação
Canelado fino e textura 'stucco', branco RAL 9030

Faturação mínima: 5 m²

ES Panel sandwich

Con secciones de 500 o 610mm de altura útil y espesor de 40mm
Interior de poliuretano expandido de gran densidad y libre de CFC
Encaje antipinzamiento preveniendo cualquier situación de riesgo durante su movimentación
Goma de EPDM incrustada en el macho del panel
Área de refuerzo, inferior y superior, de acero galvanizado, en el interior del panel
Gran aislamiento térmico y acústico

Cara exterior

Chapa de aluminio de 0,6mm prelacada con tratamiento antioxidación
Acanalado largo y textura 'stucco'

Cara interior

Chapa de aluminio de 0,6mm prelacada y con tratamiento antioxidación
Acanalado fino y textura 'stucco', blanco RAL 9030

Facturación mínima: 5 m²

**FR Panneau sandwich**

En section de 500 ou 610mm de hauteur utile et épaisseur de 40mm
 Intérieur en polyuréthane à haute densité et dépourvu de CFC
 Emboîtement anti-pince doigt, évitant toute possibilité de coincement pendant la marche de la porte
 Plaques de renfort en acier galvanisé, inférieures et supérieures, à l'intérieur du panneau
 Joint EPDM encastré dans la partie mâle du panneau
 Forte isolation thermique et acoustique

Coté extérieur

Tôle d'aluminium lisse de 0,6mm pré-laqué et avec traitement antioxydant
 Rainuré large et texture 'stucco'

Coté intérieur:

Tôle d'aluminium de 0,6mm pré-laqué et avec traitement antioxydant
 Rainuré fin et texture 'stucco', blanc RAL 9030

Minimum de facturation: 5 m²

EN Sandwich panel

In sections of 500 or 610mm height and thickness of 40mm
 Interior of high density expanded polyurethane, CFC free
 Safe-finger interlocking system preventing any trapping episodes during door's moving cycle
 EPDM rubber seal grooved into the panel's top
 Reinforced panel's structure with galvanized steel strips in top and bottom ends of the panel
 Great thermal and acustic insulation

Outer appearance:

0,6mm aluminium plate, pre-powdercoated and with anti-corrosion treatment
 Wide ribbed pattern and 'stucco' emboss

Inner appearance:

0,6mm aluminium plate, pre-powdercoated and with anti-corrosion treatment
 Thin ribbed pattern and 'stucco' emboss, pre-powdercoated white RAL 9030

Minimum charge: 5 m²

Panel Standard, alumínio bruto
 Panel Estándar, aluminio bruto
 Panneau Standard, aluminium brut
 Standard Panel, plain aluminium



PSLMALU	Alumínio, acrílico simples transparente Aluminio, acrílico simple transparente Aluminium, plexiglas simple transparent Aluminium, single glazed acrylic, transparent	m ²
---------	---	----------------

Opção, Acabamento lacado
 Opción, Acabado lacado
 Option, Finition laquée
 Option, Powdercoated finishing

NS.TLACA2	Duas faces (m ²) Dos caras (m ²) Deux faces (m ²) Both sides (sqm)	m ²
-----------	---	----------------

Acréscimo, Opção acrílico
 Adición, Opción acrílico
 Ajout, Option plexiglas
 Addition, Option acrylic

NS.ALUT175OPDC	Acrílico duplo, transparente Acrílico doble, transparente Plexiglas double, transparent Double glazed acrylic, transparent	3+10+3	m ²
----------------	---	--------	----------------

NS.ALUT175OPFS	Acrílico simples, fosco Acrílico simple, opaco Plexiglas simple, dépoli Single glazed acrylic, frosted	3,0 (mm)	m ²
----------------	---	----------	----------------

NS.ALUT175OPDF	Acrílico duplo, fosco Acrílico doble, opaco Plexiglas double, dépoli Double glazed acrylic, frosted	3+10+3	m ²
----------------	--	--------	----------------

	Grelha de ventilação em alumínio Rejilla de ventilación de aluminio Grille de ventilation en aluminium Aluminium ventilation grid	△	Preço sob consulta Precio a consultar Prix sur demande Price on request
--	--	---	--

	Chapa de aço microperfurada Chapa de acero microperforada Tôle d'acier microperforée Micro-perforated steel sheet	△	Preço sob consulta Precio a consultar Prix sur demande Price on request
--	--	---	--

Porta-homem LM Alu, incluída no portão
 Puerta peatonal LM Alu, suministrada con el portón
 Portillon LM Alu, inclus dans la porte
 Wicket door LM Alu, included in the gate

PS.900011	Alumínio, acrílico simples transparente Aluminio, acrílico simple transparente Aluminium, plexiglas simple transparent Aluminium, single glazed acrylic, transparent	m ²
-----------	---	----------------



PT ALU

Panel construído com perfis de alumínio extrudido e espessura de 40mm
 Janelas em acrílico simples ou duplo (3+10+3mm), transparente ou fosco, chapa cega ou perforada
 Vedantes em EPDM de grande densidade em todo o perímetro
 Variedade de combinações com painéis sandwich (mod. 40AA/CA/LA)
 Encaixe anti-dedo prevenindo qualquer hipótese de entalamento durante a operação do portão
 Grande visibilidade para o interior e aproveitamento da luz solar

Faturação mínima: 5 m²

ES LM ALU

Panel construído con perfiles de aluminio extruido y 40mm de espesor.
 Ventanas en acrílico simple o doble (3+10+3mm), transparente o mate, placa ciega o perforada.
 Juntas de EPDM de alta densidad en todo el perímetro.
 Variedad de combinaciones con paneles sándwich (mod. 40AA/CA/LA).
 El sistema antipinzamiento evita cualquier posibilidad de atrapamiento durante el funcionamiento de la puerta.
 Gran visibilidad hacia el interior y aprovechamiento de la luz solar.

Facturación mínima: 5 m²

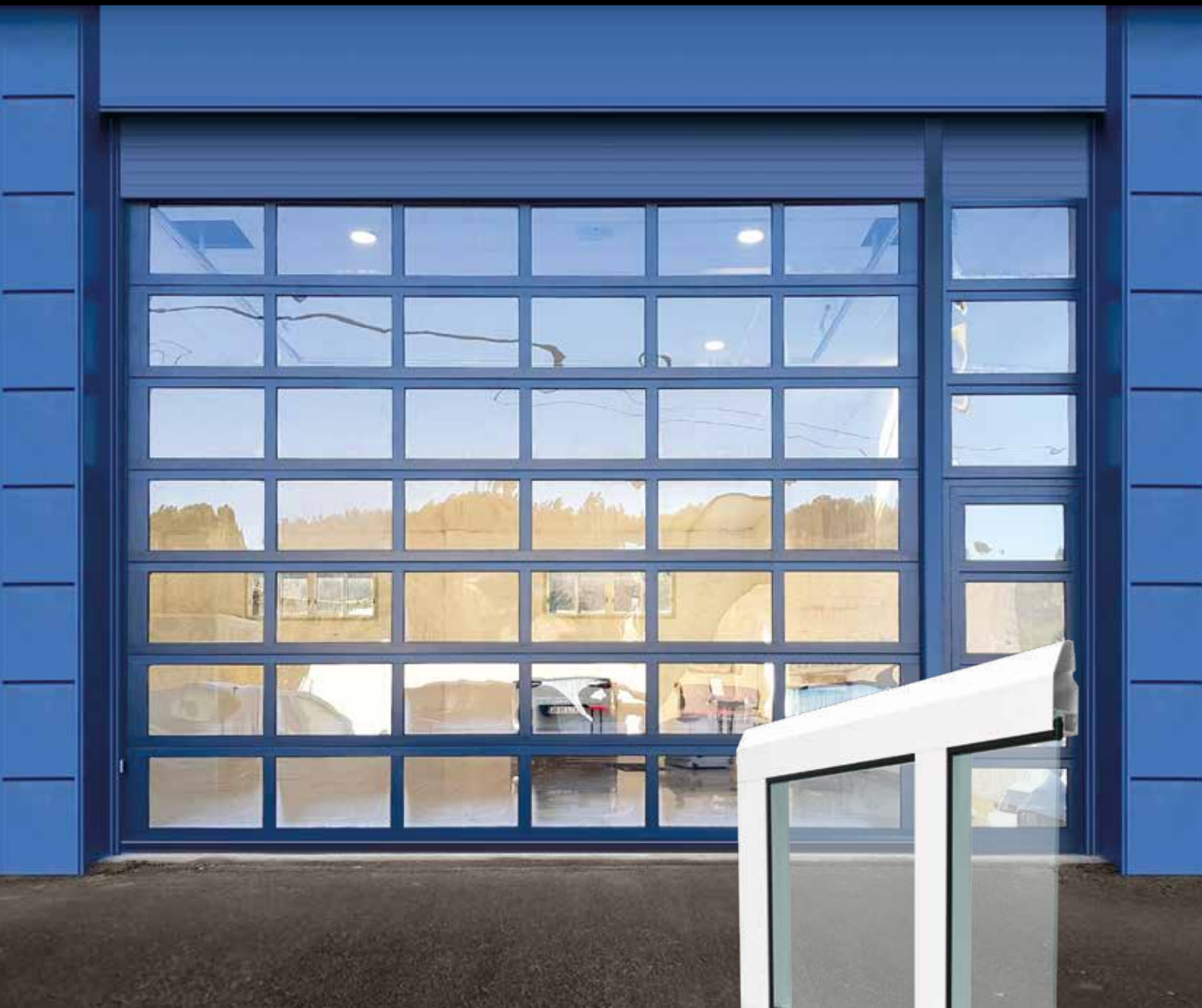
**FR LM ALU**

Panneau construit avec des profils en aluminium extrudé et une épaisseur de 40mm.
Fenêtres en acrylique simple ou double (3+10+3mm), transparentes ou mates, aveugles ou perforées.
Joints en EPDM haute densité sur tout le périmètre.
Variété de combinaisons avec des panneaux sandwichs (mod. 40AA/CA/LA).
Dispositif anti-pince-doigts empêchant toute possibilité de coincement pendant le fonctionnement du portail.
Grande visibilité vers l'intérieur et utilisation de la lumière du soleil

Minimum de facturation: 5 m²

EN LM ALU

Panel built with extruded aluminium profiles and 40mm thickness.
Windows in single or double acrylic (3+10+3mm), transparent or matte, blind or perforated plate.
Seals in high density EPDM around the perimeter.
Variety of combinations with sandwich panels (mod. 40AA/CA/LA).
Anti-finger-trap preventing any possibility of entrapment during operation of the gate.
High visibility towards the inside and use of sunlight.

Minimum charge: 5 m²

Painel Standard 80mm Panel Estándar 80mm Panneau Standard 80mm Standard Panel 80mm			
---	--	--	--

PS.080CA00	Branco Blanco Blanc White	RAL9010	m ²
------------	------------------------------------	---------	----------------

Pintura a pedido Pintura por pedido Peinture sur demande Paint on demand			
---	--	--	--

NS.PINT	Catálogo RAL (1 face) Carta RAL (1 cara) Nuancier RAL (1 face) RAL colour chart (1 side)		m ²
---------	---	--	----------------

NS.PINTM	Afinação por amostra (1 face) Afinación por muestra (1 cara) Afinación par échantillon (1 face) Sampled colour (1 side)		m ²
----------	--	--	----------------

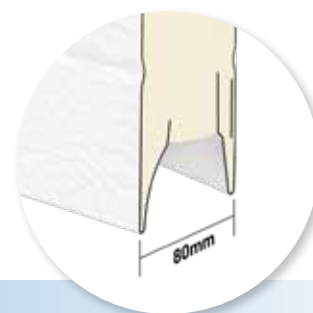

- Painel com grande capacidade de isolamento térmico e acústico, ideal para a indústria frigorífica
- Panel con gran capacidad de aislamiento térmico y acústico, ideal para la industria del frío
- Panneau à grande capacité d'isolation thermique et acoustique, idéal pour l'industrie de la réfrigération
- Panel with great capacity for thermal and acoustic insulation, ideal for the refrigeration industry

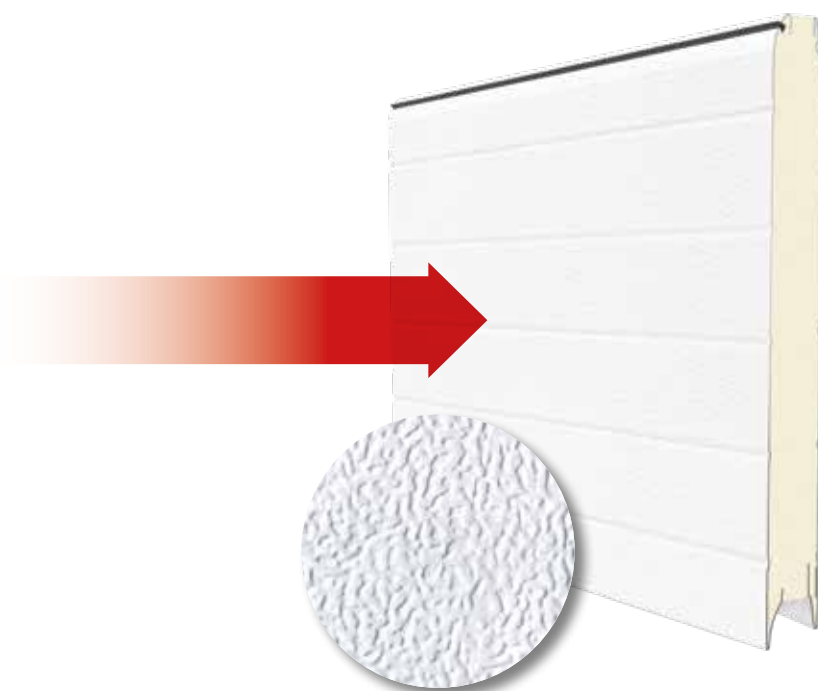

PT Painel sandwich

Em secções de 500mm ou 610mm de altura útil e espessura de 80mm
Interior em poliuretano expandido de alta densidade e isento de CFC
Encaixe anti-dedo prevenindo qualquer hipótese de entalamento durante a operação do portão
Vedante em EPDM embutido no macho do painel
Chapas de reforço em aço galvanizado, inferior e superior, no interior do painel
Grande isolamento térmico e acústico

Cara exterior

Chapa de aço de 0,4mm pré-lacada e com tratamento anti-oxidação
Canelado fino e textura 'stucco'

Cara interior

Chapa de aço de 0,4mm pré-lacada e com tratamento anti-oxidação
Canelado fino e textura 'stucco', branco Ral 9010

Faturação mínima: 5 m²

ES Panel sandwich

Con secciones de 500mm o 610mm de altura útil y espesor de 80mm
Interior de poliuretano expandido de gran densidad y libre de CFC
Encaje antipinzamiento preveniendo cualquier situación de riesgo durante su movimentación
Goma de EPDM incrustada en el macho del panel
Área de refuerzo, inferior y superior, de acero galvanizado, en el interior del panel
Gran aislamiento térmico y acústico

Cara exterior

Chapa de acero 0,4mm prelacada y con tratamiento antioxidación
Acanalado fino y textura 'stucco'

Cara interior

Chapa liso de acero de 0,4mm prelacada y con tratamiento antioxidación
Acanalado fino y textura 'stucco', blanco ral 9010

Facturación mínima: 5 m²

**FR Panneau sandwich**

En section de 500mm ou 610mm de hauteur utile et épaisseur de 80mm
 Intérieur en polyuréthane à haute densité et dépourvu de CFC
 Emboîtement anti-pince doigt, évitant toute possibilité de coincement pendant la marche de la porte
 Plaques de renfort en acier galvanisé, inférieures et supérieures, à l'intérieur du panneau
 Joint EPDM encastré dans la partie mâle du panneau
 Forte isolation thermique et acoustique

Coté extérieur

Tôle d'acier de 0,4mm pré-laqué et avec traitement antioxydant
 Rainuré fin et texture 'stucco'

Coté intérieur:

Tôle d'acier de 0,4mm pré-laqué et avec traitement antioxydant
 Rainuré fin et texture 'stucco', blanc RAL 9010

Minimum de facturation: 5 m²

EN Sandwich panel

In sections of 500mm or 610mm height and thickness of 80mm
 Interior of high density expanded polyurethane, CFC free
 Safe-finger interlocking system preventing any trapping episodes during door's moving cycle
 EPDM rubber seal grooved into the panel's top
 Reinforced panel's structure with galvanized steel strips in top and bottom ends of the panel
 Great thermal and acoustic insulation

Outer appearance:

0,4mm galvanized steel plate, pre-powdercoated and with anti-corrosion treatment
 Thin ribbed and 'stucco' texture

Inner appearance:

0,4mm galvanized steel plate, pre-powdercoated and with anti-corrosion treatment
 Thin ribbed pattern and 'stucco' emboss, pre-powdercoated white RAL 9010

Minimum charge: 5 m²

PORTA-HOMEM SECCIONADO

PUERTA PEATONAL SECCIONADO | PORTILLON SECTIONNELLE | WICKET DOOR SECTIONAL



Porta-homem, incluída no portão Puerta peatonal, suministrada con el portón Portillon, inclus dans la porte Wicket door, included with gate		
PS.900002	Porta com fechadura de 3 pontos Puerta con cerradura de 3 puntos Porte avec serrure de 3 points Door with 3 points lock	uni.
PS.900003	Porta com barra anti-pânico Puerta con barra antipánico Porte avec barre anti-panique Door with panic bar	uni.
PS.900100	Acréscimo, perfis imitação madeira Adición, perfiles imitación madera Ajout, profiles imitation bois Addition, light/dark timber design profiles	uni.*
Opções, Porta-homem Opciones, Puerta peatonal Options, Portillon Options, Wicket door		
11.100033	Mola de fecho de braço deslizante Cierrapuertas de guía deslizante Ferme-porte avec bras glissière Door closer with slide channel	uni.
02.400511	Kit sensor de segurança magnético s/ fios Kit interruptor de seguridad magnético inalámbrico Kit interrupteur de sécurité magnétique sans fils Kit wireless safety magnetic switch	uni.

PT Porta-homem embutida no portão, construída em perfis de alumínio lacado.
Vedantes EPDM em todo o aro da porta (móvel e fixo) e vedante duplo no perfil da soleira para maior estanquicidade.
Perfil de dobradiça muito discreto e resistente, em toda a altura da porta.
Medida standard de referência: largura 800 mm e altura 2000 mm. Estas medidas podem ser alteradas consoante necessidades estruturais. No caso de ter necessidades específicas de obra, indique no seu pedido.
Sentido de abertura obrigatório para o exterior; Sentido standard para a direita (vista exterior).
Fechadura incluída, com espelhos e puxador à cor do painel.
Em portões com painel almofadado, as medidas da porta-homem estão dependentes do padrão dos painéis.
Soleira reforçada com apenas 30mm de altura para portas com largura de 4000mm máximo
Soleira reforçada alta para portas com largura superior a 4000mm até 5500mm máximo

ES Puerta peatonal insertada en el portón, fabricada con perfiles de aluminio lacado.
Juntas de EPDM en todo el marco de la puerta (móvil y fija) y doble junta en el perfil del umbral para una mayor estanquidad.
Perfil de bisagra muy discreto y resistente, a lo largo de toda la altura de la puerta.
Medidas estándar de referencia: anchura 800mm y altura 2000mm. Estas medidas pueden modificarse en función de las necesidades estructurales. Si tiene requisitos de construcción específicos, indíquelo en su pedido.
Dirección de apertura obligatoria hacia el exterior; dirección estándar hacia la derecha (vista exterior).
Cerradura incluida, con espejos y asa del color del panel.
En las puertas con panel acolchado, las medidas de la puerta de hombre dependen del patrón de los paneles.
Umbral reforzado de sólo 30mm de altura para puertas de 4000mm de ancho máximo
Umbral reforzado alto para puertas de más de 4000mm de ancho hasta 5500mm como máximo



FR Portillon encastré dans la portail, réalisée en profilés d'aluminium laqués.
 Joints en EPDM sur l'ensemble du cadre de la porte (mobile et fixe) et double joint sur le profilé de seuil pour une meilleure étanchéité.
 Profil de charnière très discret et résistant, sur toute la hauteur de la porte.
 Mesures de référence standard: largeur 800mm et hauteur 2000mm. Ces mesures peuvent être modifiées en fonction des besoins structurels. Si vous avez des exigences particulières en matière de construction, veuillez les indiquer dans votre commande.
 Sens d'ouverture obligatoire vers l'extérieur ; sens standard vers la droite (vue extérieure).
 Serrure incluse, avec miroirs et poignée dans la couleur du panneau.
 Sur les portails avec panneau rembourré, les dimensions de la porte d'homme dépendent du motif des panneaux.
 Le seuil renforcé ne mesure que 30mm de haut pour les portes d'une largeur maximale de 4000mm.
 Le seuil haut renforcé pour les portes de plus de 4000mm de large jusqu'à 5500mm

EN Wicket door embedded into the gate, built of lacquered aluminium profiles.
 EPDM seals on the entire door frame (mobile and fixed) and double seal on the threshold profile for greater watertightness.
 Very discreet and resistant hinge profile, along the entire height of the door.
 Standard reference measurements: width 800mm and height 2000mm. These measurements may be altered according to structural needs. If you have specific construction requirements, please indicate them in your order.
 Mandatory opening direction to the outside; standard direction to the right (outside view).
 Lock included, with mirrors and handle in the colour of the panel.
 On gates with padded panel, the measurements of the man-door are dependent on the pattern of the panels.
 The reinforced threshold is only 30mm high for doors up to 4000mm wide.
 Reinforced high threshold for doors over 4000mm wide up to 5500mm.

PORTA-HOMEM SECCIONADO LM SLIM

PUERTA PEATONAL LM SLIM | PORTILLON LM SLIM | WICKET DOOR LM SLIM



Porta-homem, incluída no portão Puerta peatonal, suministrada con el portón Portillon, inclus dans la porte Wicket door, included with gate		
PS.900004	Porta com fechadura de 3 pontos Puerta con cerradura de 3 puntos Porte avec serrure de 3 points Door with 3 points lock	uni.
Opções, Porta-homem Opciones, Puerta peatonal Options, Portillon Options, Wicket door		
11.100033	Mola de fecho de braço deslizante Cierrapuertas de guía deslizante Ferme-porte avec bras glissière Door closer with slide channel	uni.
02.400511	Kit sensor de segurança magnético s/ fios Kit interruptor de seguridad magnético inalámbrico Kit interrupteur de sécurité magnétique sans fils Kit wireless safety magnetic switch	uni.

PT Porta-homem embutida no portão, construída em perfis de alumínio lacado.
Vedantes EPDM em todo o aro da porta (móvel e fixo) e vedante duplo no perfil da soleira para maior estanquicidade.
Perfil de dobradiça muito discreto e resistente, em toda a altura da porta.
Medida standard de referência: largura 800 mm e altura 2000 mm. Estas medidas podem ser alteradas consoante necessidades estruturais. No caso de ter necessidades específicas de obra, indique no seu pedido.
Sentido de abertura obrigatório para o exterior; Sentido standard para a direita (vista exterior).
Fechadura incluída, com espelhos e puxador à cor do painel.
Em portões com painel almofadado, as medidas da porta-homem estão dependentes do padrão dos painéis.
Soleira reforçada com apenas 30mm de altura para portas com largura de 4000mm máximo
Soleira reforçada alta para portas com largura superior a 4000mm até 5500mm máximo

ES Puerta peatonal insertada en el portón, fabricada con perfiles de aluminio lacado.
Juntas de EPDM en todo el marco de la puerta (móvil y fija) y doble junta en el perfil del umbral para una mayor estanquidad.
Perfil de bisagra muy discreto y resistente, a lo largo de toda la altura de la puerta.
Medidas estándar de referencia: anchura 800mm y altura 2000mm. Estas medidas pueden modificarse en función de las necesidades estructurales. Si tiene requisitos de construcción específicos, indíquelo en su pedido.
Dirección de apertura obligatoria hacia el exterior; dirección estándar hacia la derecha (vista exterior).
Cerradura incluida, con espejos y asa del color del panel.
En las puertas con panel acolchado, las medidas de la puerta de hombre dependen del patrón de los paneles.
Umbral reforzado de sólo 30mm de altura para puertas de 4000mm de ancho máximo
Umbral reforzado alto para puertas de más de 4000mm de ancho hasta 5500mm como máximo



FR Portillon encastré dans la portail, réalisée en profilés d'aluminium laqués.
 Joints en EPDM sur l'ensemble du cadre de la porte (mobile et fixe) et double joint sur le profilé de seuil pour une meilleure étanchéité.
 Profil de charnière très discret et résistant, sur toute la hauteur de la porte.
 Mesures de référence standard: largeur 800mm et hauteur 2000mm. Ces mesures peuvent être modifiées en fonction des besoins structurels. Si vous avez des exigences particulières en matière de construction, veuillez les indiquer dans votre commande.
 Sens d'ouverture obligatoire vers l'extérieur ; sens standard vers la droite (vue extérieure).
 Serrure incluse, avec miroirs et poignée dans la couleur du panneau.
 Sur les portails avec panneau rembourré, les dimensions de la porte d'homme dépendent du motif des panneaux.
 Le seuil renforcé ne mesure que 30mm de haut pour les portes d'une largeur maximale de 4000mm.
 Le seuil haut renforcé pour les portes de plus de 4000mm de large jusqu'à 5500mm

EN Wicket door embedded into the gate, built of lacquered aluminium profiles.
 EPDM seals on the entire door frame (mobile and fixed) and double seal on the threshold profile for greater watertightness.
 Very discreet and resistant hinge profile, along the entire height of the door.
 Standard reference measurements: width 800mm and height 2000mm. These measurements may be altered according to structural needs. If you have specific construction requirements, please indicate them in your order.
 Mandatory opening direction to the outside; standard direction to the right (outside view).
 Lock included, with mirrors and handle in the colour of the panel.
 On gates with padded panel, the measurements of the man-door are dependent on the pattern of the panels.
 The reinforced threshold is only 30mm high for doors up to 4000mm wide.
 Reinforced high threshold for doors over 4000mm wide up to 5500mm.

PORTA-HOMEM ECLIPSE

PUERTA PEATONAL ECLIPSE | PORTILLON ECLIPSE | WICKET DOOR ECLIPSE



Porta-homem mod. A, incluída no portão
Puerta peatonal mod. A, suministrada con el portón
Portillon mod. A, inclus dans la porte
Wicket door mod. A, included with gate

PL.900001	Porta com fechadura de 2 pontos Puerta con cerradura de 2 puntos Porte avec serrure de 2 points Door with 2 points lock	uni.
-----------	--	------

Porta-homem mod. B, incluída no portão
Puerta peatonal mod. B, suministrada con el portón
Portillon mod. B, inclus dans la porte
Wicket door mod. B, included with gate

PL.900002	Porta com fechadura de 1 ponto Puerta con cerradura de 1 punto Porte avec serrure de 1 point Door with 1 point lock	uni.
-----------	--	------

Opção, Porta-homem
Opción, Puerta peatonal
Option, Portillon
Option, Wicket door

11.100043	Mola de fecho de braço deslizante Cierrapuertas de guía deslizante Ferme-porte avec bras glissière Door closer with slide channel	uni.
-----------	--	------

02.400511	Kit sensor de segurança magnético s/ fios Kit interruptor de seguridad magnético inalámbrico Kit interrupteur de sécurité magnétique sans fils Kit wireless safety magnetic switch	uni.
-----------	---	------

PT Duas possibilidades de porta-homem embutida no portão.

Sentido de abertura obrigatório para o interior.

Largura de passagem da porta-homem: 600mm máximo.

Especificações do modelo A:

Porta completamente discreta

Régua de alinhamento da porta-homem em aço galvanizado, lacado a branco, com dobradiça embutida e carrinho para guia superior.

Localização obrigatória da porta no primeiro painel do lado do fecho.

Fechadura de 2 pontos verticais incluída, trancando na régua de alinhamento e na guia inferior.

Especificações do modelo B:

Construída totalmente em perfis de alumínio, com painel igual ao do portão.

Fechadura de 1 ponto incluída, montada com puxador ou torniquete.

Localização possível em qualquer painel do portão excepto no painel de abertura.

ES Dos possibilidades de portas de hombre integradas en el portón.

Dirección de apertura obligatoria hacia el interior.

Ancho de paso de la puerta de hombre: 600mm como máximo.

Especificaciones del modelo A:

Puerta completamente discreta.

Regla de alineación de la puerta peatonal de acero galvanizado lacado blanco, con bisagra incrustada y soporte rodante para la guía superior.

Ubicación obligatoria en el primero panel del lado de la apertura.

Cerradura de 2 puntos verticales suministrada, para bloqueo en la regla de alineación y guía inferior.

Especificaciones del modelo B:

Construido íntegramente en perfiles de aluminio, con panel igual al de la puerta.

Cerradura de 1 punto incluída, montada con manilla o torniquete.

Ubicación posible en cualquier panel de la puerta, excepto en el panel de apertura.



FR Deux possibilités de porte d'homme intégrées au portail.
Sens d'ouverture obligatoire vers l'intérieur.
Largeur de passage de la porte d'homme: 600mm maximum.

Spécifications du modèle A:

Porte totalement discrète.
Règle d'alignement du portillon en acier galvanisé laqué blanc, avec charnière intégré et charriot pour le guide supérieur.
Lieu obligatoire du portillon sur le premier panneau de l'ouverture.
Serrure de 2 points verticaux incluse, verrouillage dans la règle d'alignement et guide inférieur.

Spécifications du modèle B:

Construit entièrement en profilés d'aluminium, avec un panneau égal à celui du portail.
Serrure à 1 point incluse, montée avec une poignée ou un tourniquet.
Emplacement possible sur n'importe quel panneau du portail, sauf le panneau d'ouverture.

EN Two possible options for built-in wicket door.
Obligatory opening direction for the interior.
Passage width of wicket door: 600mm.

Model A specifications:

Completely discrete door.
Wicket door alignment plate of white coated galvanized steel, with built-in hinge and upper guide hanger.
Obligatory location of the door on the first panel on the opening side.
Included with a 2 points vertical lock, clamping to the alignment plate and bottom guide.

Model B specifications:

Produced entirely of aluminium profiles and in the same panel as the door.
Included with a 1 point lock, mounted with a handle or a ring handle.
Assembly possible in any door panel.

PORTA DE SERVIÇO LATERAL



PUERTA PEATONAL LATERAL | PORTE PIÉTONNE LATÉRALE | PEDESTRIAN LATERAL DOOR

Porta de serviço lateral, textura woodgrain Puerta peatonal lateral, textura woodgrain Porte piétonne latéral, texture woodgrain Pedestrian lateral door, woodgrain texture		Fechadura 1 ponto Cerradura 1 punto Serrure 1 point 1 point lock		Fechadura 3 pontos Cerradura 3 puntos Serrure 3 point 3 point lock		Barra anti-pânico Barra antipánico Barre anti-panique Panic bar	
Branco Blanco Blanc White	RAL 9010	PS.801000	uni.	PS.801100	uni.	PS.801200	uni.
Bege Beige Beige Beige	RAL 1015	PS.801006	uni.	PS.801106	uni.	PS.801206	uni.
Cinza Gris Gris Grey	RAL 9006	PS.801007	uni.	PS.801107	uni.	PS.801207	uni.
	RAL 9007	PS.801015		PS.801115		PS.801215	
	RAL 7011	PS.801011		PS.801111		PS.801211	
	RAL 7016	PS.801012		PS.801112		PS.801212	
Verde Verde Vert Green	RAL 6005 RAL 6009	PS.801001 PS.801010	uni.	PS.801101 PS.801110	uni.	PS.801201 PS.801210	uni.
Castanho Marrón Marron Brown	RAL 8014	PS.801002	uni.	PS.801102	uni.	PS.801202	uni.
Azul Azul Bleu Blue	RAL 5010	PS.801008	uni.	PS.801108	uni.	PS.801208	uni.
Vermelho Rojo Rouge Red	RAL 3000	PS.801009	uni.	PS.801109	uni.	PS.801209	uni.
Catálogo RAL Carta RAL Nuancier RAL RAL coulor chart		PS.801099	uni.	PS.801199	uni.	PS.801299	uni.
Afinação por amostra Ajuste por muestra Accordage par échantillon Colour tuning		PS.801098	uni.	PS.801198	uni.	PS.801298	uni.
Porta de serviço lateral, textura liso Puerta peatonal lateral, textura lisa Porte piétonne latéral, texture lisse Service lateral door, super flat texture		Fechadura 1 ponto Cerradura 1 punto Serrure 1 point 1 point lock		Fechadura 3 pontos Cerradura 3 puntos Serrure 3 point 3 point lock		Barra anti-pânico Barra antipánico Barre anti-panique Panic bar	
Branco Blanco Blanc White	RAL 9010	PS.801020	uni.	PS.801120	uni.	PS.801220	uni.
LM Sablé	RAL 7016	PS.801025	uni.	PS.801125	uni.	PS.801225	uni.
LM Sablé Noir	Ral 9005	PS.801028	uni.	PS.801128	uni.	PS.801228	uni.
LM Silver		PS.801091	uni.	PS.801191	uni.	PS.801291	uni.
LM Inox		PS.801094	uni.	PS.801194	uni.	PS.801294	uni.
LM Corten		PS.801093	uni.	PS.801193	uni.	PS.801293	uni.
Imitação de madeira clara/escuro Imitación de madera clara/oscura Imitation bois clair/foncé Light/Drark timber coated design		PS.801013 PS.801014	uni.	PS.801113 PS.801114	uni.	PS.801213 PS.801214	uni.
	Imitação de madeira clara/escuro, 2 lados Imitación de madera clara/oscura, dos caras Imitation bois clair/foncé, deux faces Light/Drark timber coated design, two-sided	PS.801073 PS.801074	uni.	PS.801173 PS.801174	uni.	PS.801273 PS.801274	uni.
Catálogo RAL Carta RAL Nuancier RAL RAL colour chart		PS.801029	uni.	PS.801129	uni.	PS.801229	uni.
Afinação por amostra Afinación por muestra Afination par échantillon Sampled colour		PS.801028	uni.	PS.801128	uni.	PS.801228	uni.
Porta de serviço lateral, modelo LM ALU Puerta peatonal lateral, modelo LM ALU Porte piétonne latéral, modèle LM ALU Service lateral door, model LM ALU		Fechadura 1 ponto Cerradura 1 punto Serrure 1 point 1 point lock					
Alumínio bruto, acrílico simples transparente Aluminio bruto, acrílico simple transparente Aluminium brut, plexiglas simple transparent Plain aluminium, single glazed transparent		PS.8010AL	uni				

PT Porta de serviço construída com perfis de alumínio lacado e seções de painel condizente às do portão seccionado (possível em painel sandwich ou LM Alu)
Vedantes EPDM em todo o aro da porta (móvel e fixo) para maior estanquidade
Medida standard de referência: largura 800mm, altura 2000mm, outras medidas mediante consulta.
Em portas de painel almofadado, as medidas estão dependentes do padrão do painel. No caso de ter necessidades específicas de obra, indique no seu pedido
Aplicação dentro de vão com sentido de abertura opcional
Fechadura de 1 ou 3 pontos incluída, com espelhos e puxador à cor do painel.
Em portas encostadas ao portão é necessária a aquisição de uma ombreira falsa para a sua separação.
As portas com altura inferior ao vão poderão ser acompanhadas por uma padieira falsa, em painel ou chapa canelada, acabada com perfil em toda a volta.

ES Puerta de servicio fabricada con perfiles de aluminio lacado y secciones de panel a juego con las de la puerta seccional (posibilidad de panel sándwich o LM Alu)
Juntas de EPDM en todo el marco de la puerta (móvil y fija) para aumentar la estanqueidad
Medida de referencia estándar: anchura 800mm, altura 2000mm, otras dimensiones a petición.
En el caso de las puertas con paneles acolchados, las medidas dependen del estándar del panel. Si tiene requisitos de construcción específicos, indíquelo en su pedido
Aplicación dentro de una puerta con dirección de apertura opcional
Cerradura de 1 o 3 puntos incluida, con espejos y asa en el color del panel.
En el caso de las puertas enrasadas con el portón, es necesario adquirir una jamba falsa para separarla. Las puertas con una altura inferior al vano pueden ir acompañadas de una falsa jamba, de panel o chapa ondulada, acabada con un perfil en todo su contorno.

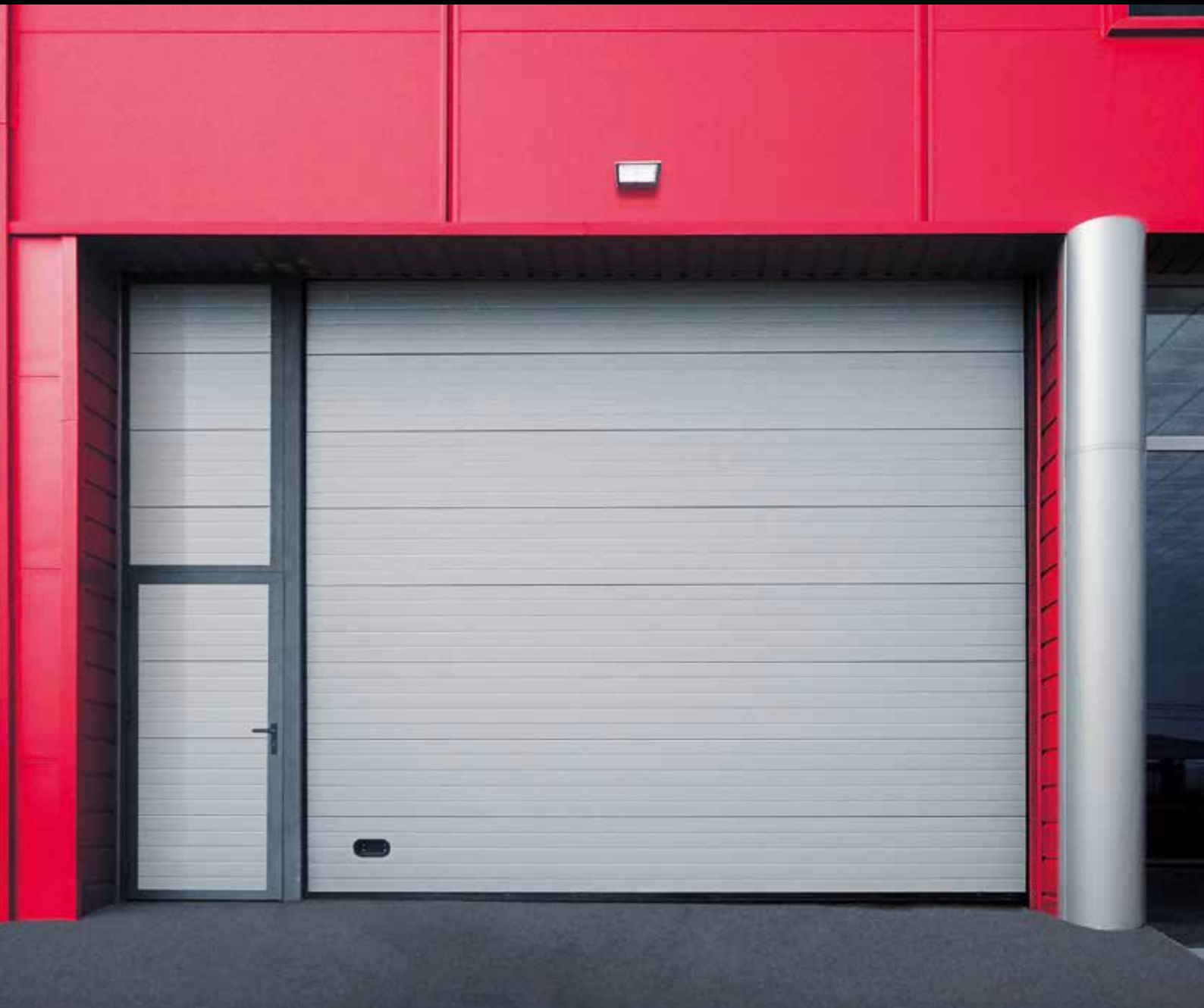

FR Porte de service en profilés d'aluminium laqués et sections de panneaux assorties à celles de la porte sectionnelle (panneau sandwich ou LM Alu possible)
 Joints en EPDM sur l'ensemble du cadre de la porte (mobile et fixe) pour une meilleure étanchéité.
 Mesure de référence standard: largeur 800mm, hauteur 2000mm, autres dimensions sur demande.
 Pour les portes à panneaux rembourrés, les mesures dépendent du standard du panneau. Si vous avez des exigences particulières en matière de construction, veuillez les indiquer dans votre commande.
 Application dans un passage de porte avec sens d'ouverture optionnel
 Serrure 1 ou 3 points incluse, avec miroirs et poignée dans la couleur du panneau.
 Pour les portes affleurant le portail, il est nécessaire d'acheter un faux montant pour le séparer. Les portes dont la hauteur est inférieure à la portée peuvent être accompagnées d'un faux montant, en panneau ou en tôle ondulée, terminé par un profilé tout autour.

EN Service door made of lacquered aluminium profiles and panel sections matching those of the sectional door (sandwich panel or LM Alu possible)
 EPDM seals on entire door frame (mobile and fixed) for increased watertightness
 Standard reference measurement: width 800mm, height 2000mm, other dimensions on request.
 For padded-panel doors, the measurements depend on the standard of the panel. If you have specific construction requirements, please state them in your order
 Application within a doorway with optional direction of opening
 1 or 3 point lock included, with mirrors and handle in the colour of the panel.
 For doors flush with the gate, it is necessary to purchase a false jamb to separate it. Doors with a height below the span may be accompanied by a false jamb, in panel or corrugated sheet metal, finished with a profile all round.



> ESPECIFICAÇÕES TÉCNICAS

ESPECIFICACIONES TÉCNICAS | SPÉCIFICATIONS TECHNIQUES | TECHNICAL SPECIFICATIONS



PAINEL LUSO



PANEL LUSO | PANNEAU LUSO | PANEL LUSO

	40LA Luso LM Sablé Noir	40LA Luso LM Sablé	40LA Luso LM Silver	40LA Luso LM Inox	40LA Luso LM Corten
Ref. Luso 500	53.500228	53.500225	53.500291	53.500294	53.500293
Ref. Luso 610	53.610228	53.610225	53.610291	53.610294	53.610293
Cara exterior Cara exterior Coté extérieur Outer side	Textura lisa aço Textura lisa acero Texture lisse acier Fine Texture steel	Textura lisa aço Textura lisa acero Texture lisse acier Fine Texture steel	Textura lisa aço Textura lisa acero Texture lisse acier Fine Texture steel	Textura lisa aço Textura lisa acero Texture lisse acier Fine Texture steel	Textura lisa aço Textura lisa acero Texture lisse acier Fine Texture steel
Cor exterior Color exterior Couleur extérieur Colour outer side	RAL 9005	RAL 7016	Similar Ral. 9006 Similar Ral. 9006 Similaire Ral. 9006 Similar Ral. 9006	Imitação inox escovado Imitación acero inoxidable cepillado Imitation acier inox brossé Brushed stainless steel imitation	Imitação aço corten Imitación acero corten Imitation acier corten Corten steel imitation
Cara interior Cara interior Coté intérieur Inner side	Canelado stucco aço Acanalado stucco acero Rainuré stucco acier Ribbed stucco steel	Canelado stucco aço Acanalado stucco acero Rainuré stucco acier Ribbed stucco steel	Canelado stucco aço Acanalado stucco acero Rainuré stucco acier Ribbed stucco steel	Canelado stucco aço Acanalado stucco acero Rainuré stucco acier Ribbed stucco steel	Canelado stucco aço Acanalado stucco acero Rainuré stucco acier Ribbed stucco steel
Cor interior Color interior Couleur intérieur Colour inner side	RAL 9010	RAL 9010	RAL 9010	RAL 9010	RAL 9010
Preço Luso 500 Precio Luso 500 Prix Luso 500 Price Luso 500	ml	ml	ml	ml	ml
Preço Luso 610 Precio Luso 610 Prix Luso 610 Price Luso 610	ml	ml	ml	ml	ml
	40LA Luso LM Liso Liso 40LA Luso LM Liso Liso 40LA Luso LM Lisse Lisse 40LA Luso LM Super Flat	40LA Luso LM Liso Liso 40LA Luso LM Liso Liso 40LA Luso LM Lisse Lisse 40LA Luso LM Super Flat	40LA Luso LM Liso Liso 40LA Luso LM Liso Liso 40LA Luso LM Lisse Lisse 40LA Luso LM Super Flat	40LA Luso LM Liso Liso 40LA Luso LM Liso Liso 40LA Luso LM Lisse Lisse 40LA Luso LM Super Flat	40CA Luso LM Micro-Friso Liso 40CA Luso LM Microacanelado Liso 40CA Luso LM Micronervuré Lisse 40CA Luso LM Micro Ribbed Flat
Ref. Luso 500	53.500220	53.500222	53.500224	53.500223	53.500240
Ref. Luso 610	53.610220	53.610222	53.610224	53.610223	53.610240
Cara exterior Cara exterior Coté extérieur Outer side	Textura lisa aço Textura lisa acero Texture lisse acier Fine Texture steel	Textura lisa aço Textura lisa acero Texture lisse acier Fine Texture steel	Textura lisa aço Textura lisa acero Texture lisse acier Fine Texture steel	Textura lisa aço Textura lisa acero Texture lisse acier Fine Texture steel	Micro-friso liso aço Microacanelado liso acero Micronervuré lisse acier Micro ribbed flat steel
Cor exterior Color exterior Couleur extérieur Colour outer side	RAL 9010	RAL 7016	Imitação de madeira escura Imitación de madera oscura Imitation de bois foncé Dark wood imitation	Imitação madeira clara Imitación de madera clara Imitation de bois clair Light wood imitation	RAL 9010
Cara interior Cara interior Coté intérieur Inner side	Canelado stucco aço Acanalado stucco acero Rainuré stucco acier Ribbed stucco steel	Canelado stucco aço Acanalado stucco acero Rainuré stucco acier Ribbed stucco steel	Canelado stucco aço Acanalado stucco acero Rainuré stucco acier Ribbed stucco steel	Canelado stucco aço Acanalado stucco acero Rainuré stucco acier Ribbed stucco steel	Canelado stucco aço Acanalado stucco acero Rainuré stucco acier Ribbed stucco steel
Cor interior Color interior Couleur intérieur Colour inner side	RAL 9010	RAL 9010	RAL 9010	RAL 9010	RAL 9010
Preço Luso 500 Precio Luso 500 Prix Luso 500 Price Luso 500	ml	ml	ml	ml	ml
Preço Luso 610 Precio Luso 610 Prix Luso 610 Price Luso 610	ml	ml	ml	ml	ml



	40LA Luso LM Friso Único Liso 40LA Luso LM Unicanalado Liso 40LA Luso LM Mono Ligne Lisse 40LA Luso LM Centre Ribbed S. Flat	40LA Luso LM Friso Único Liso 40LA Luso LM Unicanalado Liso 40LA Luso LM Mono Ligne Lisse 40LA Luso LM Centre Ribbed S. Flat	40LA Luso LM Friso Único Liso 40LA Luso LM Unicanalado Liso 40LA Luso LM Mono Ligne Lisse 40LA Luso LM Centre Ribbed S. Flat	40LA Luso LM Friso Único Liso 40LA Luso LM Unicanalado Liso 40LA Luso LM Mono Ligne Lisse 40LA Luso LM Centre Ribbed S. Flat	40LA Luso LM Friso Único Liso 40LA Luso LM Unicanalado Liso 40LA Luso LM Mono Ligne Lisse 40LA Luso LM Centre Ribbed S. Flat
--	---	---	---	---	---

Ref. Luso 500	53.500230	53.500234	53.500233	2 Caras 53.500277	2 Caras 53.500276
---------------	-----------	-----------	-----------	---------------------	---------------------

Ref. Luso 610					
---------------	--	--	--	--	--

Cara exterior Cara exterior Côté extérieur Outer side	Friso único liso aço Unicanalado liso acero Mono ligne lisse acier Centre ribbed flat steel	Friso único liso aço Unicanalado liso acero Mono ligne lisse acier Centre ribbed flat steel	Friso único liso aço Unicanalado liso acero Mono ligne lisse acier Centre ribbed flat steel	Friso único liso aço Unicanalado liso acero Mono ligne lisse acier Centre ribbed flat steel	Friso único liso aço Unicanalado liso acero Mono ligne lisse acier Centre ribbed flat steel
Cor exterior Color exterior Couleur extérieur Colour outer side	RAL 9010	Imitação de madeira escura Imitación de madera oscura Imitation de bois foncé Dark wood imitation	Imitação madeira clara Imitación de madera clara Imitation de bois clair Light wood imitation	Imitação de madeira escura Imitación de madera oscura Imitation de bois foncé Dark wood imitation	Imitação madeira clara Imitación de madera clara Imitation de bois clair Light wood imitation
Cara interior Cara interior Côté intérieur Inner side	Canelado stucco aço Acanalado stucco acero Rainuré stucco acier Ribbed stucco steel	Canelado stucco aço Acanalado stucco acero Rainuré stucco acier Ribbed stucco steel	Canelado stucco aço Acanalado stucco acero Rainuré stucco acier Ribbed stucco steel	Canelado liso aço Acanalado liso acero Rainuré lisse acier Ribbed flat steel	Canelado liso aço Acanalado liso acero Rainuré lisse acier Ribbed flat steel
Cor interior Color interior Couleur intérieur Colour inner side	RAL 9010	RAL 9010	RAL 9010	Imitação de madeira escura Imitación de madera oscura Imitation de bois foncé Dark wood imitation	Imitação madeira clara Imitación de madera clara Imitation de bois clair Light wood imitation

Preço Luso 500 Precio Luso 500 Prix Luso 500 Price Luso 500	ml	ml	ml	ml	ml
--	----	----	----	----	----

Preço Luso 610 Precio Luso 610 Prix Luso 610 Price Luso 610					
--	--	--	--	--	--



	40CA Luso LM Friso Único Woodgrain 40CA Luso LM Unicanalado Woodgrain 40CA Luso LM Mono Ligne Woodgrain 40CA Luso LM Centre Ribbed Woodgrain	40CA Luso LM Canelado Liso 40CA Luso LM Acanalado Liso 40CA Luso LM Rainuré Lisse 40CA Luso LM Ribbed S. Flat	40CA Luso LM Canelado Liso 40CA Luso LM Acanalado Liso 40CA Luso LM Rainuré Lisse 40CA Luso LM Ribbed S. Flatt	40CA Luso LM Canelado Liso 40CA Luso LM Acanalado Liso 40CA Luso LM Rainuré Lisse 40CA Luso LM Ribbed S. Flat	40CA Luso LM Canelado Liso 40CA Luso LM Acanalado Liso 40CA Luso LM Rainuré Lisse 40CA Luso LM Ribbed S. Flatt
--	---	--	---	--	---

Ref. Luso 500	53.500280	53.500214	53.500213	2 Caras 53.500274	2 Caras 53.500273
---------------	-----------	-----------	-----------	---------------------	---------------------

Ref. Luso 610		53.610214	53.610213	2 Caras 53.610274	2 Caras 53.610273
---------------	--	-----------	-----------	---------------------	---------------------

Cara exterior Cara exterior Côté extérieur Outer side	Friso único woodgrain aço Unicanalado woodgrain acero Mono ligne woodgrain acier Centre ribbed woodgrain steel	Canelado liso aço Acanalado liso acero Rainuré lisse acier Ribbed flat steel	Canelado liso aço Acanalado liso acero Rainuré lisse acier Ribbed flat steel	Canelado liso aço Acanalado liso acero Rainuré lisse acier Ribbed flat steel	Canelado liso aço Acanalado liso acero Rainuré lisse acier Ribbed flat steel
Cor exterior Color exterior Couleur extérieur Colour outer side	RAL 9010	Imitação de madeira escura Imitación de madera oscura Imitation de bois foncé Dark wood imitation	Imitação madeira clara Imitación de madera clara Imitation de bois clair Light wood imitation	Imitação de madeira escura Imitación de madera oscura Imitation de bois foncé Dark wood imitation	Imitação madeira clara Imitación de madera clara Imitation de bois clair Light wood imitation
Cara interior Cara interior Côté intérieur Inner side	Canelado stucco aço Acanalado stucco acero Rainuré stucco acier Ribbed stucco steel	Canelado stucco aço Acanalado stucco acero Rainuré stucco acier Ribbed stucco steel	Canelado stucco aço Acanalado stucco acero Rainuré stucco acier Ribbed stucco steel	Canelado liso aço Acanalado liso acero Rainuré lisse acier Ribbed flat steel	Canelado liso aço Acanalado liso acero Rainuré lisse acier Ribbed flat steel
Cor interior Color interior Couleur intérieur Colour inner side	RAL 9010	RAL 9010	RAL 9010	Imitação de madeira escura Imitación de madera oscura Imitation de bois foncé Dark wood imitation	Imitação madeira clara Imitación de madera clara Imitation de bois clair Light wood imitation

Preço Luso 500 Precio Luso 500 Prix Luso 500 Price Luso 500	ml	ml	ml	ml	ml
--	----	----	----	----	----

Preço Luso 610 Precio Luso 610 Prix Luso 610 Price Luso 610		ml	ml	ml	ml
--	--	----	----	----	----



	40CA Luso LM Canelado Woodgrain 40CA Luso LM Acanalado Woodgrain 40CA Luso LM Rainuré Woodgrain 40CA Luso LM Ribbed Woodgrain	80CA Luso LM 80	40AA Luso LM Almofadado Woodgrain 40AA Luso LM Cuarterones Woodgrain 40AA Luso LM Cassette Woodgrain 40AA Luso LM Panelled Woodgrain	40AA Luso LM Almofadado Woodgrain 40AA Luso LM Cuarterones Woodgrain 40AA Luso LM Cassette Woodgrain 40AA Luso LM Panelled Woodgrain	40AA Luso LM Almofadado Woodgrain 40AA Luso LM Cuarterones Woodgrain 40AA Luso LM Cassette Woodgrain 40AA Luso LM Panelled Woodgrain
Ref. Luso 500	53.500209	53.580200	Esp. 210mm 53.500120 Esp. 300mm 53.500130	Esp. 210mm 53.500124 Esp. 300mm 53.500134	Esp. 210mm 53.500123 Esp. 300mm 53.500133
Ref. Luso 610	53.610209	53.680200	Esp. 210mm 53.610120 Esp. 300mm 53.610130	Esp. 210mm 53.610124 Esp. 300mm 53.610134	Esp. 210mm 53.610123 Esp. 300mm 53.610133
Cara exterior Cara exterior Côté extérieur Outer side	Canelado woodgrain aço Acanalado woodgrain acero Rainuré woodgrain acier Ribbed woodgrain steel	Canelado stucco aço Acanalado stucco acero Rainuré stucco acier Ribbed stucco steel	Almofadado woodgrain aço Cuarterones woodgrain acero Cassette woodgrain acier Panelled woodgrain steel	Almofadado woodgrain aço Cuarterones woodgrain acero Cassette woodgrain acier Panelled woodgrain steel	Almofadado woodgrain aço Cuarterones woodgrain acero Cassette woodgrain acier Panelled woodgrain steel
Cor exterior Color exterior Couleur extérieur Colour outer side	RAL 3000	RAL 9010	RAL 9010	Imitação de madeira escura Imitación de madera oscura Imitation de bois foncé Dark wood imitation	Imitação madeira clara Imitación de madera clara Imitation de bois clair Light wood imitation
Cara interior Cara interior Côté intérieur Inner side	Canelado stucco aço Acanalado stucco acero Rainuré stucco acier Ribbed stucco steel	Canelado stucco aço Acanalado stucco acero Rainuré stucco acier Ribbed stucco steel	Canelado stucco aço Acanalado stucco acero Rainuré stucco acier Ribbed stucco steel	Canelado stucco aço Acanalado stucco acero Rainuré stucco acier Ribbed stucco steel	Canelado stucco aço Acanalado stucco acero Rainuré stucco acier Ribbed stucco steel
Cor interior Color interior Couleur intérieur Colour inner side	RAL 9010	RAL 9010	RAL 9010	RAL 9010	RAL 9010
Preço Luso 500 Precio Luso 500 Prix Luso 500 Price Luso 500	ml	ml	ml	ml	ml
Preço Luso 610 Precio Luso 610 Prix Luso 610 Price Luso 610	ml	ml	ml	ml	ml



	40CA Luso LM Sea	40CA Luso Lm Canelado Alumínio 40CA Luso Lm Acanalado Alumínio 40CA Luso Lm Rainuré Alumínio 40CA Luso Lm Ribbed Alumínio
Ref. Luso 500	53.500251	53.500250
Ref. Luso 610	—————	53.610250
Cara exterior Cara exterior Côté extérieur Outer side	Friso único liso alumínio Unicanalado liso alumínio Mono ligne lisse aluminium Centre ribbed flat aluminium	Canelado stucco alumínio Acanalado stucco alumínio Rainuré stucco aluminium Ribbed stucco aluminium
Cor exterior Color exterior Couleur extérieur Colour outer side	RAL 9030	RAL 9030
Cara interior Cara interior Côté intérieur Inner side	Canelado stucco alumínio Acanalado stucco alumínio Rainuré stucco aluminium Ribbed stucco aluminium	Canelado stucco alumínio Acanalado stucco alumínio Rainuré stucco aluminium Ribbed stucco aluminium
Cor interior Color interior Couleur intérieur Colour inner side	RAL 9030	RAL 9030
Preço Luso 500 Precio Luso 500 Prix Luso 500 Price Luso 500	ml	ml
Preço Luso 610 Precio Luso 610 Prix Luso 610 Price Luso 610	—————	ml

Isolamento do Painel Luso Aislamiento del Panel Luso Isolation des Panneau Luso Panel Insulation Luso	
Densidade Densidad Densité Density	± 45 Kg/m ³
Força de aderência Fuerza de agarre Force de préhension Adhesive strength	± 0.10 MPa
Resistência à compressão Resistencia a la compresión Résistance à la compression Resistance to compression	± 0.13 MPa
Módulo de elasticidade em compressão Módulo de elasticidad en compresión Module d'élasticité en compression Modulus of elasticity in compression	± 2.68 MPa
Condutividade térmica Conductividad térmica Conductivité thermique Thermal conductivity	± 0.14 W/mk
Índice de células fechadas Índice de células cerradas Indexe de cellules fermées Closed cell index	± 94%

› CONFIGURAÇÃO DE PORTAS SECCIONADAS

CONFIGURACIONES DE LAS PUERTAS | CONFIGURATIONS DES PORTES | DOOR CONFCIGURATIONS

MAX. 8x6m



Portas certificadas até 8x6m
Puertas certificadas hasta 8x6m
Portes certifiés jusqu'à 8x6m
Doors certificated up to 8x6m

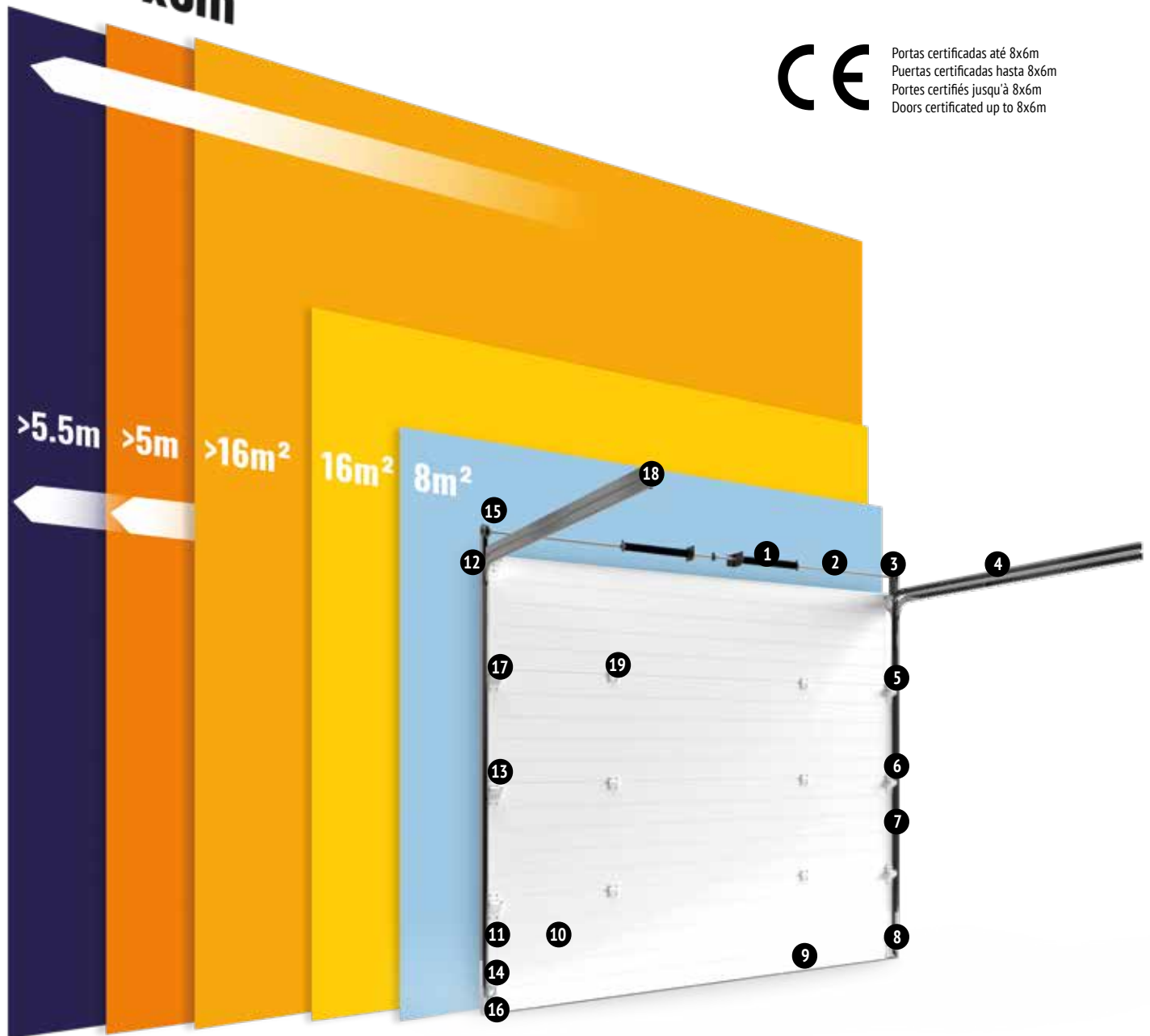

1

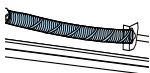

- Molas de torsão em aço galvanizado ou fosfatado para 25 000 ciclos e topos de mola em alumínio fundido. Sistema de segurança de ruptura de molas montado em cada mola
- Muelles de torsión de acero galvanizado o fosfatado para 25 000 ciclos y topos de muelles de aluminio fundido. Sistema de seguridad de muelles aplicado en cada muelle
- Ressorts de torsion en acier galvanisé ou phosphaté pour 25 000 cycles et avec dessus de ressort en aluminium fondu. Système de sécurité de rupture de ressort assemblé à chacun
- Torsion springs of galvanized or phosphate steel for 25 000 cycles and spring cones of casted aluminium. Spring rupture safety device applied in each

Opção: acabamento lacado ou inox
Opción: acabado lacado o inox
Option: finition laqué ou inox
Option: powdercoated or stainless steel

2

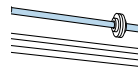

- Veio oco ou maciço em aço galvanizado. Inteiro ou repartido com união ajustável em ferro fundido
- Eje hueco o macizo de acero galvanizado. Entero o repartido con acoplamiento ajustable de hierro fundido
- Axe creux ou massif en acier galvanisé. Entier ou réparti avec union ajustable en fer fondu
- Hollow or solid galvanized steel shaft. Whole or divided with casted iron adjustable coupler

Opção: acabamento lacado ou inox
Opción: acabado lacado o inox
Option: finition laqué ou inox
Option: powdercoated or stainless steel

3

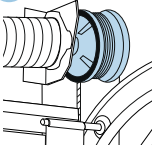

- Roldanas em alumínio fundido com cabo de aço galvanizado
- Poleas de aluminio fundido con cable de acero galvanizado
- Poulies en aluminium fondu avec câble en acier galvanisé
- Pulleys of casted aluminium with galvanized steel cable

Opção: cabo de aço inox
 Opción: cable de acero inox
 Option: câble d'acier inox
 Option: stainless steel cable

4

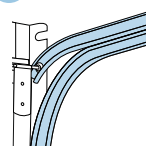

- Calhas verticais e horizontais em aço galvanizado
- Guías verticales y horizontales en acero galvanizado
- Guides verticales et horizontales en acier galvanisé

Opção: acabamento lacado ou inox
 Opción: acabado lacado o inox
 Option: finition laqué ou inox
 Option: powdercoated or stainless steel

5

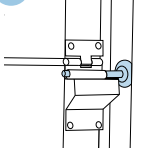

- Rodízios com veio em aço galvanizado e roda em nylon branco com rolamento de esferas
- Rodillos con eje de acero galvanizado y rueda de nylon de color blanco con rodamiento de bolas
- Galets avec axe en acier galvanisé et roulette en nylon blanc avec roulement de sphères
- Rollers with galvanized steel shaft and white nylon wheel with ball bearing

Opção: Rodízio com veio em inox
 Opción: Rodillos con eje de acero inoxidable
 Option: Galets avec axe en acier inox
 Option: Rollers shaft in stainless steel

6

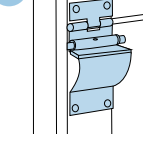

- Dobradiças residenciais com casquilho em nylon
- Bisagras residenciales con manga de nylon
- Charnières résidentielles avec manche de nylon
- High strength residential hinges with nylon roller glove

Opção: acabamento lacado
 Opción: acabado lacado
 Option: finition laqué
 Option: powdercoated

7

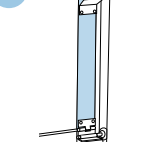

- Topos de painel em chapa de aço pré-lacada para grande duração e melhor fixação da ferragem
- Cantoneras de panel en chapa de acero prelacado para larga duración y una mejor fijación del herraje
- Montants d'extrêmes de panneau en acier pré-laqué pour une grande durée et meilleure fixation des ferrures
- Top side caps of precoated galvanized steel for high resistance and best hardware fixation

8

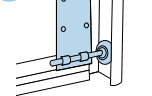

- Suportes de cabo simples em aço galvanizado
- Soportes de cable simple de acero galvanizado
- Support de câble simple en acier galvanisé
- Regular cable fixing bracket of galvanized steel

9

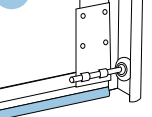

- Perfis de remate em chapa de aço galvanizado, pré-lacada a preto e vedantes em EPDM preto
- Perfiles de remate en chapa de acero galvanizado, prelacado negro y gomas de EPDM negro
- Profils aux extrémités en acier galvanisé pré-laqué en noir et joints d'étanchéité en EPDM noir
- Top and bottom profiles of galvanized steel, black precoated and black EPDM seals

10



- Puxador de Sobrepor LMP
- Tirador de superposición LMP
- Poignée de tirage superposée LMP
- Overlay LMP pull handle

11

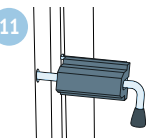

- Trinco lateral em aço galvanizado com veio redondo maciço
- Cerrojo de acero galvanizado con eje redondo macizo
- Verrou latéral en acier galvanisé avec un axe massif
- Lateral bolt with solid round bar, galvanized steel

12

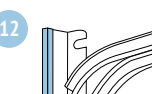

- Vedantes laterais em PVC vulcanizado preto
- Gomas laterales de PVC vulcanizado negro
- Joints latéraux en PVC vulcanisés noir
- Side seals of black vulcanized PVC

13

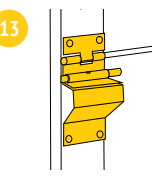

- Dobradiças reforçadas com ponto de lubrificação
- Bisagras reforzadas con agujero de lubricación
- Charnières renforcées avec point de lubrification
- Reinforced hinges with lubrication point

Opção: acabamento lacado ou inox
 Opción: acabado lacado o inox
 Option: finition laquée ou inox
 Option: powdercoated or stainless steel

14

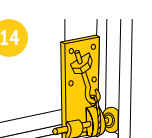

- Suportes de cabo ajustável em alumínio fundido
- Soportes de cable ajustables de aluminio fundido
- Supports de câble ajustable en aluminium fondu
- Adjustable cable fixing bracket of casted aluminium

15

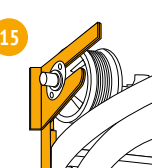

- Guias verticais montadas com suporte de veio tipo 'garfo' duplo
- Guías verticales con soporte de eje tipo 'horquilla' doble
- Rails verticaux avec support d'arbre type 'fourchette' double
- Vertical guides with double fork-type shaft support

16

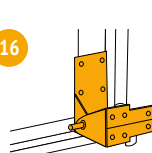

- Sistema de segurança de ruptura de cabos (para-quadras) em aço galvanizado
- Sistema de seguridad de rotura de cables (paracaídas) de acero galvanizado
- Système de sécurité de rupture de câble (pare-chutes) en acier galvanisé
- Cable break safety device (parachute) of galvanized steel

17

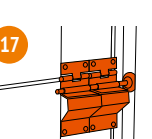

- Dobradiças laterais duplas, em aço galvanizado
- Bisagras laterales dobles, de acero galvanizado
- Charnières latérales doubles, en acier galvanisé
- Double lateral hinges of galvanized steel

18



- Perfil de ligação traseira das calhas horizontais em aço galvanizado
- Galga trazera de unión de guías horizontales en acero galvanizado
- Barre d'encartement pour rails horizontaux en acier galvanisé
- Horizontal tracks stabiliser profile of galvanized steel

19

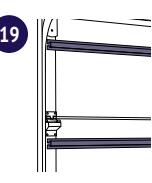

- Perfis de reforço 'ômega' em aço galvanizado, em todos os painéis.
- Perfiles de refuerzo 'omega' de acero galvanizado, en todos los paneles
- Profil de renfort 'omega' en acier galvanisé, dans tous les panneaux
- Reinforcement 'omega' profile of galvanized steel, on all panels

Em painéis de cores claras, a partir dos 5500mm, em cores escuras dos 4000mm.
 En paneles de color claro a partir de 5500mm, en colores oscuros a partir de 4000mm.
 En panneaux de couleur claire à partir de 5500mm, en couleurs foncées à partir de 4000mm.
 In light coloured panels starting from 5500mm, in dark colours from 4000mm.

> CALHAS E GUIAS

ÂNGULOS Y GUIAS | RAILS ET GUIDES | RAILS AND TRACKS

Calha vertical / padieira

Guía vertical / dintel

Rail vertical / linteau

Vertical lift / headroom

- Calhas e guías com abraçadeiras de reforço
- Veio maciço
- Perfil de união traseira
- Capacidade máxima das molas: 25 000 ciclos
- Para-queda
- Ângulos y guías con abrazaderas de refuerzo
- Eje macizo
- Perfil de acoplamiento trasero de guías
- Capacidad máxima de los muelles: 25 000 ciclos
- Paracaídas
- Rails et guides renforcés avec supports
- Arbre massif
- Profil d'union arrière des guides
- Capacité maximale des ressorts: 25 000 cycles
- Parachutes
- Rails and tracks reinforced by plates
- Rails and tracks reinforced by plates
- Solid shaft
- Rear-end tracks connection profile
- Maximum springs capacity: 25 000
- Parachutes

Calha semi-vertical / padieira

Guía sobreelevada / dintel

Rail semi-vertical / linteau

High lift / headroom

- Guias horizontais em curva simples
- Calhas e guías com abraçadeiras de reforço
- Veio maciço
- Perfil de união traseira
- Capacidade máxima das molas: 25 000 ciclos
- Para-queda
- Guias horizontales de curva simple
- Ângulos y guías con abrazaderas de refuerzo
- Eje macizo
- Perfil de acoplamiento trasero de guías
- Capacidad máxima de los muelles: 25 000 ciclos
- Paracaídas
- Rails horizontaux à courbe simple
- Rails et guides renforcés avec supports
- Arbre massif
- Profil d'union arrière des guides
- Capacité maximale des ressorts: 25 000 cycles
- Parachutes
- Single curve horizontal tracks
- Rails and tracks reinforced by plates
- Solid shaft
- Rear-end tracks connection profile
- Maximum springs capacity: 25 000 cycles
- Parachutes

Calha normal / padieira

Guía normal / dintel

Rail normal / linteau

Normal lift / headroom

- Guias horizontais em curva simples
- Veio oco
- Capacidade máxima das molas: 100 000 ciclos
- Guias horizontales de curva simple
- Eje tubular
- Capacidad máxima de los muelles: 100 000 ciclos
- Rails horizontaux à courbe simples
- Arbre creux
- Capacité maximale des ressorts: 100 000 cycles
- Single curve horizontal tracks
- Hollow shaft
- Maximum springs capacity: 100 000 cycles

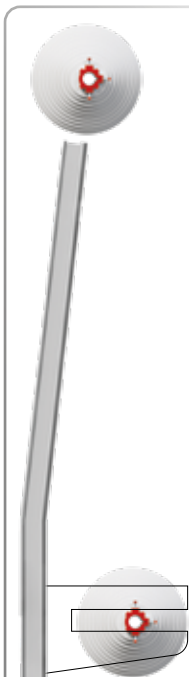

- Molas rebaixadas | Suporte 'garfo' duplo
- Muelles rebajadas | Soporte 'horquilla' doble
- Ressorts surbaissés | Support 'fourchette' double
- Lowered springs | Double 'fork-type' support

H + 500mm

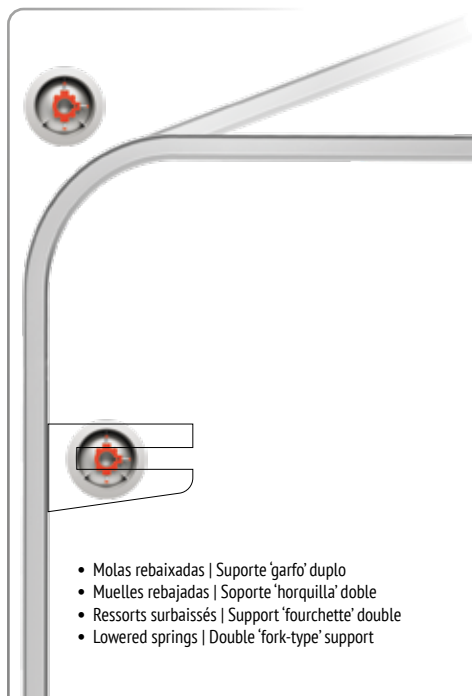

- Molas rebaixadas | Suporte 'garfo' duplo
- Muelles rebajadas | Soporte 'horquilla' doble
- Ressorts surbaissés | Support 'fourchette' double
- Lowered springs | Double 'fork-type' support

Min. 700mm

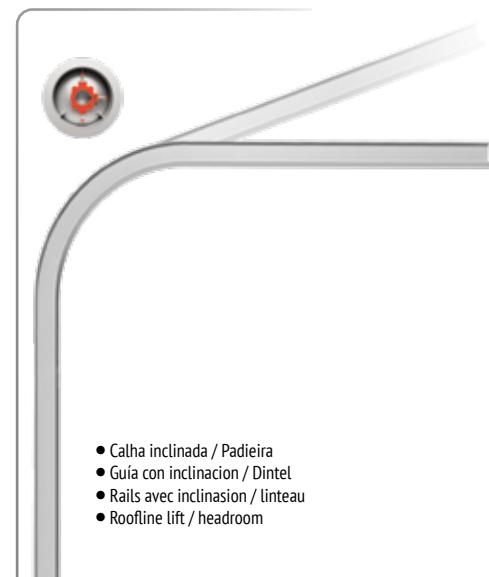

- Calha inclinada / Padieira
- Guía con inclinación / Dintel
- Rails avec inclinaison / linteau
- Roofline lift / headroom

330 > 500mm

100mm Ombreira mínima | Marco mínimo | Écoiçon minimum | Minimum jamb

Calha dupla / padieira
Guía doble / dintel
Rail double / linteau
Low lift / headroom

- Guias horizontais em curva dupla
- Veio oco
- Capacidade máxima das molas: 50 000 ciclos
- Altura máxima da porta: 3800mm
- Guias horizontales de curva doble
- Eje tubular
- Capacidad máxima de los muelles: 50 000 ciclos
- Altura máxima de la puerta: 3800mm
- Rails horizontaux à courbe double
- Arbre creux
- Capacité maximale des ressorts: 50 000 cycles
- Hauteur maximale de la porte: 3800mm
- Double curve horizontal tracks
- Hollow shaft
- Maximum springs capacity: 50 000 cycles
- Maximum door height: 3800mm

Calha dupla reduzida / padieira
Guía doble reducida / dintel
Rail double réduit / linteau
Very low lift / headroom

- Guias horizontais em curva dupla reduzida
- Veio oco
- Capacidade máxima das molas: 50 000 ciclos
- Sistema de segurança de molas reduzido
- Altura máxima da porta: 2900mm
- Guias horizontales de curva doble reducida
- Eje tubular
- Capacidad máxima de los muelles: 50 000 ciclos
- Sistema de seguridad de muelles reducido
- Altura máxima de la puerta: 2900mm
- Rails horizontaux à courbe double réduite
- Arbre creux
- Capacité maximale des ressorts: 50 000 cycles
- Système de sécurité de ressorts réduits
- Hauteur maximale de la porte: 2900mm
- Reduced double curve horizontal tracks
- Hollow shaft
- Maximum springs capacity: 50 000 cycles
- Reduced spring rupture safety device
- Maximum door height: 2900mm

Molas atrás / padieira
Muelles atrás / dintel
Ressorts arrière / linteau
Rear mounted springs / headroom

- Guias horizontais em curva dupla
- Veio oco
- Dobradiça de topo para calha dupla
- Capacidade máxima das molas: 50 000 ciclos
- Altura máxima da porta: 3800mm
- Guias horizontales de curva doble
- Eje tubular
- Bisagra de tope para guía doble
- Capacidad máxima de los muelles: 50 000 ciclos
- Altura máxima de la puerta: 3800mm
- Rails horizontaux à courbe double
- Arbre creux
- Charnière supérieure pour rail double
- Capacité maximale des ressorts: 50 000 cycles
- Hauteur maximale de la porte: 3800mm
- Double curve horizontal tracks
- Hollow shaft
- Top hinge for double track
- Maximum springs capacity: 50 000 cycles
- Maximum door height: 3800mm

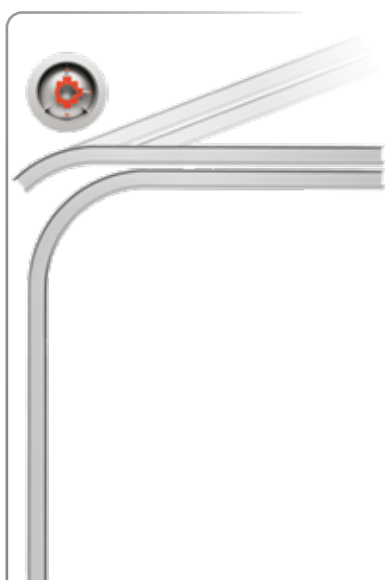

200 > 320mm



150 > 190mm

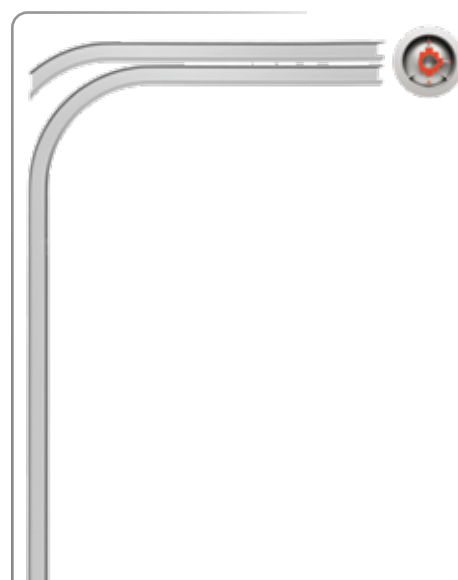

Min. 100mm

80mm Ombreira mínima | Marco mínimo | Écoiçon minimum | Minimum jamb

OPÇÕES E ACESSÓRIOS DE PORTAS SECCIONADAS

OPCIONES Y RECAMBIOS PUERTAS SECCIONALES | OPTIONS ET ACCESSOIRES PORTES SECTIONNELLES
OPTIONS & SPARES SECTIONAL DOORS

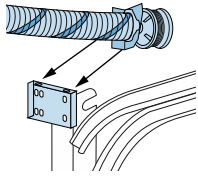

Sistema 'Clip-On' para calhas, incluído na porta Sistema 'Clip-On' para guías, suministrado con la puerta Système 'Clip-On' pour rails, inclu dans la porte 'Clip-On' system for tracks, included with door		Sistema 'Clip-On' para calhas, industrial Sistema 'Clip-On' para guías, industrial Système 'Clip-On' pour rails, industriel 'Clip-On' system for tracks, industrial	
NS.200220	'Clip-On', para portas até 3,88m de altura 'Clip-On', para puertas de hasta 3,88m de alto 'Clip-On', pour portes jusqu'à 3,88m d'hauteur 'Clip-On', for doors with maximum height of 3,88m	par *	NS.200225 'Clip-On', para portas industriais 'Clip-On', para puertas industriales 'Clip-On', pour portes industrielles 'Clip-On', for industrial doors

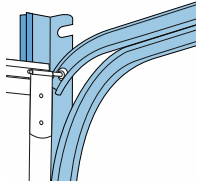

Calhas em aço galvanizado, incluídas na porta Guías de acero galvanizado, suministradas con la puerta Rails en acier galvanisé, incluent dans la porte Galvanized steel tracks, included with door		Opção, Calhas e ferragem Opción, Guías y herraje Option, Rails et ferrures Option, Tracks and hardware	
NS.200216	Calha com inclinação Guía inclinada Rail avec inclinaison Roofline angled track	par *	NS.CGL Calhas lacadas, aço galvanizado Guías lacadas, acero galvanizado Rails laqués, acier galvanisé Powdercoated tracks, galvanized steel
NS.200211	Calha semi-vertical Guía sobreelevada Rail semi-vertical High lift track	par *	NS.FL Ferragem lacada, aço galvanizado Herraje lacado, acero galvanizado Ferrures laqués, acier galvanisé Powdercoated hardware, galvanized steel
NS.200215	Calha vertical Guía vertical Rail vertical Vertical lift track	par *	NS.FINOX1 NS.FINOX2 NS.FINOX3 Calhas e ferragem, aço inox Guías y herraje, acero inox Rails et ferrure, acier inox Tracks and hardware, stainless steel
			NS.ALU Calhas e ferragem, alumínio bruto Guías y herraje, aluminio bruto Rails et ferrure, aluminium brut Tracks and hardware, raw aluminium

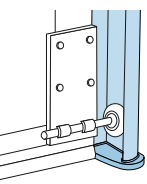

Acessórios, protecção de calhas Accesorios, protección de guías Accessoires, protection de guides Accessories, tracks' protection			
03.306996	Protecção inferior de calhas, PVC preto Protección inferior de guías, PVC negro Protection inférieure de rails, PVC noir Bottom-end tracks protection, black PVC	par	

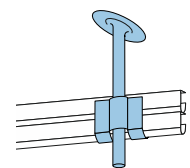

Suportes de fixação ao tecto, aço galvanizado Soportes de fijación al techo, acero galvanizado Supports de fixation au plafond, acier galvanisé Ceiling fixing brackets, galvanized steel		Opção, Suportes lacados branco RAL 9010 Opción, Soportes lacados blanco RAL 9010 Option, Supports laqués blanc RAL 9010 Option, White powdercoated brackets, RAL 9010	
03.200400	Suporte T Soporte T Support T T bracket	300mm	uni
03.200410	Suporte T Soporte T Support T T bracket	600mm	uni
03.200420	Suporte T Soporte T Support T T bracket	1000mm	uni

Opção, Molas, acresce ao valor do portão Opción, Muelles, añade al valor de la puerta Option, Ressorts, ajoute à la valeur de la porte Option, Springs, adds to value of the gate					
NS.200221	Sistema para montagem de molas atrás Sistema para montaje de muelles detrás Système pour application de ressorts arrière Rear mounted springs system		+5% *		
NS.200222	50 000 ciclos / cycles		+5% *		
NS.200223	100 000 ciclos / cycles		+10% *		
Perfil de ligação traseira de calhas, incluído na porta Galga trazera de unión de guías, suministrado con la puerta Barre d'encadrement pour rails, inclus dans la porte Tracks stabilizer profile, included with door					
03.301999	Perfil 'J', aço galvanizado Perfil 'J', acero galvanizado Profil 'J', acier galvanisé 'J' shaped profile, galvanized steel		ml		
Opção, acabamento de padieira reduzida, com vedante Opción, acabado de dintel reducido, con goma Option, finition de linteau réduit, avec joint Option, reduced headroom finishing, with seal					
03.390611	Perfil de remate de padieira, galvanizado Perfil de acabado de dintel, galvanizado Profil de finition de linteau, galvanisé Headroom finishing profile, galvanized		ml		
Perfil de reforço para painel, incluído na porta Perfil de refuerzo para panel, suministrado con la puerta Profil de renfort pour panneau, inclus dans la porte Panel reinforcement profile, included with door				Opção, Reforço lacado branco, incluído na porta Opción, Refuerzo lacado blanco, suministrado con la puerta Option, Renfort laqué blanc, inclus dans la porte Option, White powdercoated reinforcement, included with door	
NS.522999	Perfil ómega, aço galvanizado Perfil omega, acero galvanizado Profil oméga, acier galvanisé Omega profile, galvanized steel		ml*	03.200910	Perfil ómega, lacado Perfil omega, lacado Profil oméga, laqué Omega profile, powdercoated
24.0432999	Calha ómega 80x40x30x2mm, portas > 7.5m Guía omega 80x40x30x2mm, puertas > 7.5m Omega rail 80x40x30x2.00mm, portes > 7.5m Omega rail 80x40x30x2.00mm, doors > 7.5m		ml	RAL standard	ml *
Opção, Tensão de cabos, incluído na porta Opción, Tensión de los cables, suministrado con la puerta Option, Tension des câbles, inclus dans la porte Option, Steel cables tensioning, included with door					
NS.200241	Amortecedor de subida Amortiguadores de subida Amortisseurs de montée Track-end spring bumpers	100mm	par		
NS.200242	Amortecedor de subida Amortiguadores de subida Amortisseurs de montée Track-end spring bumpers	350mm	par		
NS.200243	Amortecedor de subida Amortiguadores de subida Amortisseurs de montée Track-end spring bumpers	600mm	par		
03.610510	Sistema retensor de cabos (kit) Sistema tensor de cables (kit) Système tenseur des câbles (kit) Cable tensioning system (kit)		kit		

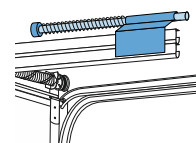
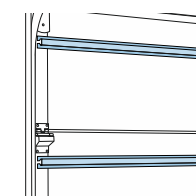
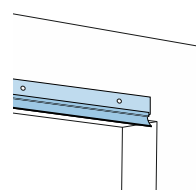
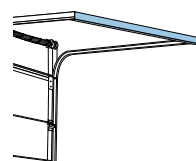
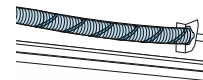

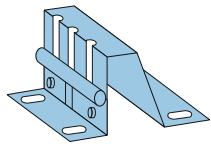

Dobradiça de topo 70mm para calha normal Bisagra superior 70mm para guía normal Charnière supérieure 70mm pour rail normal 70mm top hinge for standard rail			Opção Opción Option Option
03.200101	Galvanizada Galvanizado Galvanisé Galvanized	uni	03.200102 Aço inox Acero inoxidable Acier inoxydable Stainless steel
03.200100	Lacado branco Lacado blanco Laqué blanc White lacquered	uni	03.200501 Alumínio bruto Aluminio bruto Aluminium brut Raw Aluminium
			03.200500 Alumínio lacado Aluminio lacado Aluminium laqué Aluminium lacquered

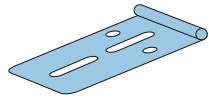

Dobradiça de topo para calha dupla de porta industrial Bisagra superior para riel de puerta industrial doble Charnière supérieure pour double rail de porte industrielle Top hinge for double industrial door track			Opção Opción Option Option
03.200131	Galvanizada Galvanizado Galvanisé Galvanized	uni	03.200132 Aço inox Acero inoxidable Acier inoxydable Stainless steel
03.200130	Lacado branco Lacado blanco Laqué blanc White lacquered	uni	

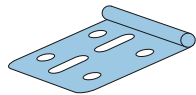

Dobradiça de topo para calha dupla de porta residencial Bisagra superior para riel de puerta residencial doble Charnière supérieure pour double rail de porte résidentiel Top hinge for double residential door track			Opção Opción Option Option
03.200136	Galvanizada Galvanizado Galvanisé Galvanized	uni	03.200536 Alumínio bruto Aluminio bruto Aluminium brut Raw Aluminium
03.200135	Lacado branco Lacado blanco Laqué blanc White lacquered	uni	03.200535 Alumínio lacado Aluminio lacado Aluminium laqué Aluminium lacquered

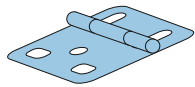

Dobradiça central Bisagra central Charnière centrale Central hinge			
03.509201	Galvanizada Galvanizado Galvanisé Galvanized	uni	
03.509200	Lacado branco Lacado blanco Laqué blanc White lacquered	uni	

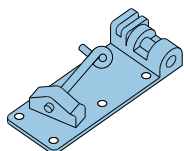

Suporte de cabo com afinação Soporte para cables con afinación Support de câble avec réglage Cable support with tuning			
03.200070	Alumínio bruto Aluminio bruto Aluminium brut Raw Aluminium	Par Par Paire Pair	uni
03.200075	Alumínio lacado Aluminio lacado Aluminium laqué Aluminium lacquered	Par Par Paire Pair	uni

Dobradiça lateral para painel anti-dedo longa Bisagra lateral para el anti-dedo largo Charnière latérale pour un long anti-fingerboard Side hinge for long anti-fingerboard		Opção Opción Option Option			
03.200144	Galvanizada Galvanizado Galvanisé Galvanized	uni	03.200145	Aço inox Acero inoxidable Acier inoxydable Stainless steel	uni
03.200143	Lacado branco Lacado blanco Laqué blanc White lacquered	uni	03.200544	Alumínio bruto Aluminio bruto Aluminium brut Raw Aluminium	uni
	03.200543		Alumínio lacado Aluminio lacado Aluminium laqué Aluminium lacquered	uni	

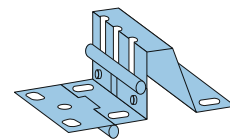

Dobradiça Lateral 60mm Bisagra lateral 60mm Charnière latérale 60mm Side hinge 60mm			
03.200044	Galvanizada Galvanizado Galvanisé Galvanized	uni	
03.200042	Lacado branco Lacado blanco Laqué blanc White lacquered	uni	

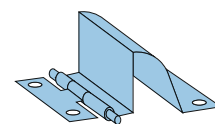

Rodízio curto para ferragem simples Rodillo corto para el herraje simple Roulette courte pour le fer à repasser simple Short castor for single ironing		Opção Opción Option Option			
03.221118	Galvanizado Galvanizado Galvanisé Galvanized	uni	03.221119	Aço inox Acero inoxidable Acier inoxydable Stainless steel	uni



Rodízio longo para ferragem dupla Rodillo corto para el herraje doble Longue roulette pour le double repassage Long castor for double ironing		Opção Opción Option Option			
03.221193	Galvanizado Galvanizado Galvanisé Galvanized	uni	03.221194	Aço inox Acero inoxidable Acier inoxydable Stainless steel	uni

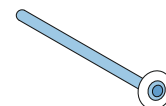

Suporte de cabo Soporte de cable Support de câble Cable holder			
03.200171	Galvanizada Galvanizado Galvanisé Galvanized	uni	
03.200170	Lacado branco Lacado blanco Laqué blanc White lacquered	uni	

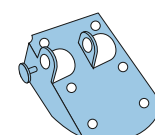

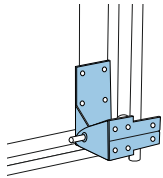
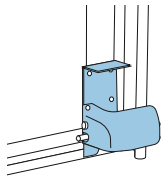

Sistema de segurança de ruptura de cabos, incluído na porta Sistema de seguridad de rotura de cables, suministrado con la puerta Système de sécurité de rupture de câble, inclus dans la porte Cable break safety device, included with door			
03.200154	Pára-queda Residencial calhas Paracaídas residencial guías Parachute résidentiel guides Residential parachute tracks	par	
03.200152	Pára-queda industrial com afinação Paracaídas industrial ajustable Parachute industriel réglable Industrial parachute, adjustable	par	
03.200151	Pára-queda industrial sem afinação Paracaídas industrial sin ajuste Parachute industriel sans réglage Industrial parachute without tuning	par	

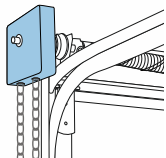

Cadernal metálico, incluído na porta Elevador de cadena, suministrado con la puerta Treuil à chaîne, inclus dans la porte Chain hoist, included with door		Acessórios para cadernal metálico Accesorios para elevador de cadena Accessoires pour treuil à chaîne Chain hoist parts	
NS.200260	Cadernal com corrente (4+4m) Elevador con cadena (4+4m) Treuil avec chaîne (4+4m) Hoist with chain (4+4m)	uni	03.200261 Corrente para cadernal Cadena para elevador Chaîne pour treuil Extra chain for hoist uni

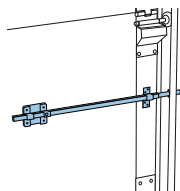

Fechadura tipo FAC, incluída na porta Cerradura tipo FAC, suministrada con la puerta Serrure type FAC, inclus dans la porte FAC lock, included with door			
NS.230330	Fechadura de segurança tipo 'FAC' Cerradura de seguridad tipo 'FAC' Serrure de sécurité type 'FAC' 'FAC' type security lock	uni	

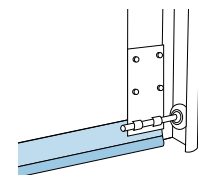

Opção, Acabamento, incluído na porta Opción, Finalización, suministrado con la puerta Option, Finition, inclus dans la porte Option, Finishing, included with door		Acessórios de acabamento Accesorios de finalización Accessoires de finition Finishing parts	
NS.502301	Perfil inferior em alumínio lacado branco Perfil inferior de aluminio lacado blanco Profil inférieur en aluminium laqué blanc Bottom aluminium profile, white powdercoated	ml*	03.402191 Capa para parafuso em PVC branco Capa para tornillos de PVC blanco Protection pour vis en PVC blanc Screw caps of white PVC €/ (100)
03.503310	Vedante inferior para sistema fotoelétrico Goma inferior para sistema fotoeléctrico Joint inférieur pour bord sensible Bottom seal for sensing edge	ml	03.402192 Capa para parafuso em PVC preto Capa para tornillos de PVC negro Protection pour vis en PVC noir Screw caps of black PVC €/ (100)

OPÇÕES E ACESSÓRIOS DE PORTA-HOMEM SECCIONADOS

OPCIONES Y RECAMBIOS PUERTA PEATONAL SECCIONALES | OPTIONS ET ACCESSOIRES PORTILLON SECTIONNELLES
 OPTIONS & SPARES SECTIONAL WICKET DOOR

Fechadura para porta-homem seccionado, em kit Cerradura para puerta peatonal seccional, kit Serrure pour portillon sectionnelle, kit Lock for wicket door sectional, kit				Acessórios para fechadura 3 pontos porta-homem Accesorios para cerradura 3 puntos puerta peatonal Accessoires pour serrure 3 points portillon Paraphernalia for wicket door 3 points lock			
03.230681	Kit fechadura 3 pontos			03.230389	Kit 3 canhões e 6 chaves (3 pontos)		
03.230683	Kit cerradura 3 puntos Kit serrure 3 points Kit 3 points lock système pour	esq. / izq. / g. / lh dir. / der. / dr. / rh	kit		Kit 3 bombillos y 6 llaves (3 puntos) Kit 3 cylindres et 6 clés (3 points) Kit 3 cylinders and 6 keys (3 points)		kit
03.230685	Kit fechadura 1 pontos			03.230999	Chave extra (canhão de 6 pinos)		
03.230687	Kit cerradura 1 puntos Kit serrure 1 points Kit 1 points lock	esq. / izq. / g. / lh dir. / der. / dr. / rh	kit		Llave extra (bombillo de 6 pines) Clé extra (serrure à 6 goupilles) Extra key (6 pin cylinder)		kit

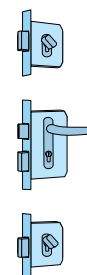

Opção, Segurança Opción, Seguridad Option, Sécurité Option, Safety			
11.100043	Mola de fecho com braço deslizante Cierrapuertas de guía deslizante Ferme-porte avec bras glissière Door closer with slide channel		kit
03.230602	Kit porta homem, fechadura 3P univ. branco Kit puerta hombre, cerradura 3P univ. blanco Kit porte homme, serrure 3P universel blanc Universal wicket door lock kit 3P white		preço sob consulta precio a petición prix sur demande price upon request

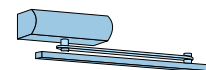

OPÇÕES E ACESSÓRIOS PORTA DE SERVIÇO LATERAL

OPCIONES Y RECAMBIOS PUERTA PEATONAL LATERAL | OPTIONS ET ACCESSOIRES PORTE PIÉTONNE LATÉRALE
 OPTIONS & SPARES PEDESTRIAN LATERAL DOOR

Fechadura para porta de serviço lateral Cerradura para puerta peatonal lateral Serrure pour porte piétonne latéral Lock for pedestrian lateral door				Acessórios para fechadura porta de serviço Accesorios para cerradura puerta peatonal lateral Accessoires pour serrure porte piétonne lateral Locks paraphernalia for pedestrian lateral door			
03.506922	Fechadura 1 ponto Cerradura 1 punto Serrure 1 point 1 point lock		uni	03.230390	Trinco eléctrico 12V Pestillo eléctrico 12V Gâche électrique 12V Electric latch 12V		uni
				03.230353	Canhão 35/25 e 3 chaves Bombillo 30/30 y 3 llaves Cylindre 30/30 et 3 clés Cylinder 30/30 and 3 keys		kit
				03.230343	Chave extra (canhão de 5 pinos) Llave extra (bombillo de 5 pines) Clé extra (serrure à 5 goupilles) Extra key (5 pin cylinder)		kit

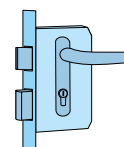

Fechadura para porta de serviço lateral Cerradura para puerta peatonal lateral Serrure pour porte piétonne latéral Lock for pedestrian lateral door			
03.506923	Fechadura 3 pontos Cerradura 3 puntos Serrure 3 points 3 points lock		uni



OMBREIRAS FALSAS

PREMARCOS | FAUX ÉCOINÇONS | JAMB POSTS

Ombreira em tubo de ferro decapado, incluída na porta Premarco de tubo de hierro decapado, suministrada con la puerta Écoinçon en tube de fer brut, inclus dans la porte Jamb post of raw iron profile, included with door				Ombreira em tubo de ferro lacado RAL, incluída na porta Premarco de tubo de hierro lacado RAL, suministrada con la puerta Écoinçon en tube de fer laqué RAL, inclus dans la porte Jamb post of iron profile powdercoated RAL, included with door						
NS.201002	Ombreira falsa Premarco Faux écoinçons Jamb post	80x40x1,5mm	ml	NS.201400	Ombreira falsa Premarco Faux écoinçons Jamb post	40x40x2mm	ml			
NS.201102	Ombreira falsa Premarco Faux écoinçons Jamb post	100x40x2mm	ml	NS.201300	Ombreira falsa Premarco Faux écoinçons Jamb post	60x40x2mm	ml			
NS.201112	Ombreira falsa Premarco Faux écoinçons Jamb post	100x100x3mm	ml	NS.201000	Ombreira falsa Premarco Faux écoinçons Jamb post	80x40x1,5mm	ml			
Ombreira em tubo de ferro lacado branco, incluída na porta Premarco de tubo de hierro lacado blanco, suministrada con la puerta Écoinçon en tube de fer laqué blanc, inclus dans la porte Jamb post of white coated iron profile, included with door				NS.201100				Ombreira falsa Premarco Faux écoinçons Jamb post	100x40x2mm	ml
NS.201001	Ombreira falsa Premarco Faux écoinçons Jamb post	80x40x1,5mm	ml	NS.201110	Ombreira falsa Premarco Faux écoinçons Jamb post	100x100x3mm	ml			
NS.201101	Ombreira falsa Premarco Faux écoinçons Jamb post	100x40x2mm	ml	NS.201142	Ombreira falsa Premarco Faux écoinçons Jamb post	120x100x3mm	ml			
NS.201111	Ombreira falsa Premarco Faux écoinçons Jamb post	100x100x3mm	ml	NS.201201	Ombreira falsa Premarco Faux écoinçons Jamb post	160x60x2mm	ml			
				NS.201200	Ombreira falsa Premarco Faux écoinçons Jamb post	200x40x2mm	ml			

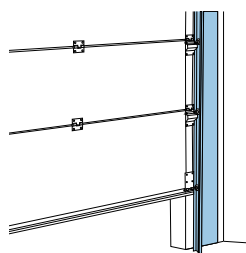

Opção Ombreiras de ferro, incluído na porta Opción Premarcos de hierro, suministrado con la puerta Option Écoinçons de fer, inclus dans la porte Option Iron jamb posts, included with door				Opção Ombreiras de ferro, incluído na porta Opción Premarcos de hierro, suministrado con la puerta Option Écoinçons de fer, inclus dans la porte Option Iron jamb posts, included with door			
NS.201999	Patilhas de fixação montadas Pestañas de fijación montadas Pâtes de fixation montées Mounted fixation plates		kit *	03.201190	Patilha de fixação, encaixe 100x40mm, galvanizada Pestaña de fijación, encaje 100x40mm, galvanizada Patte de fixation, raccord 100x40mm, zingué Fastening clamp, fitting 100x40mm, galvanised		uni. *
				03.201090	Patilha de fixação, encaixe 80x40mm, galvanizada Pestaña de fijación, encaje 80x40mm, galvanizada Patte de fixation, raccord 80x40mm, zingué Fastening clamp, fitting 80x40mm, galvanised		uni. *

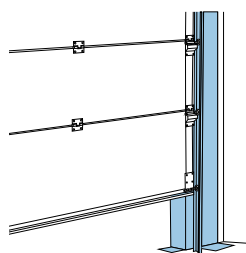

Ombreira em tubo de alumínio lacado, incluída na porta Premarco de tubo de aluminio lacado, suministrada con la puerta Écoinçon en tube de aluminium laqué, inclus dans la porte Jamb post of powdercoated aluminium profile, included with door				Ombreira em tubo de alumínio lacado a imitação de madeira Premarco de tubo de aluminio lacado a imitación de madera Écoinçon en tube de aluminium laqué a imitation bois Jamb post aluminium profile, powdercoated in timber design			
NS.202001	Ombreira falsa, branco Premarco, blanco Faux écoinçons, blanc Jamb post, white	80x40x1,5mm	ml	NS.202056 NS.202066	Madeira clara Madera clara Bois clair Light timber	80x40x5000mm 80x40x6500mm	uni.
NS.202101	Ombreira falsa, branco Premarco, blanco Faux écoinçons , blanc	100x40x1,5mm	ml	NS.202058 NS.202068	Madeira escura Madera oscura Bois foncé Dark timber	80x40x5000mm 80x40x6500mm	uni.

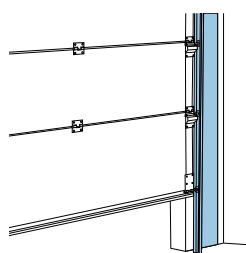

▶ PADIEIRAS FALSAS

DINTELES FALSOS | FAUX LINTEAUX | LINTEL FASCIAS

- As padieiras falsas são terminadas com perfil 'U', inferior, pintado à cor do painel escolhido. Facturação mínima: 1m²
- Los dinteles falsos tienen remate de perfil 'U', inferior, pintado en el color del panel elegido. Facturación mínima: 1m²
- Les faux linteaux sont terminés avec profile 'U', inférieur, peint à la couleur du panneau choisi. Minimum de facturation: 1m²
- Lintel fascias are included with a bottom 'U' profile, painted in the colour of the chosen panel. Minimum charge: 1m²

Padieira em painel Canelado Woodgrain, incluída na porta Dintel de panel Acanalado Woodgrain, suministrado con la puerta Lintheu en panneau Rainuré Woodgrain, inclus dans la porte Fascia of Ribbed Woodgrain panel, included with door				Opção, Acabamento pintado Opción, Acabado pintado Option, Finition peint Option, Painted finishing	
PD.040CA00	Branco Blanco Blanc White	RAL 9010	m ² *	PD.040CA99	Catálogo RAL (1 face) Carta RAL (1 cara) Nuancier RAL (1 face) RAL colour chart (1 side)
PD.040CA06	Crema Crema Beige Cream	RAL 1015	m ² *	PD.040CA98	Afinação por amostra (1 face) Afinación por muestra (1 cara) Afination par échantillon (1 face) Sampled colour (1 side)
PD.040CA07 PD.040CA15 PD.040CA11 PD.040CA12	Cinza Gris Gris Grey	RAL 9006 RAL 9007 RAL 7011 RAL 7016	m ² *		
PD.040CA01 PD.040CA10	Verde Verde Vert Green	RAL 6005 RAL 6009	m ² *		
PD.040CA02	Castanho Marrón Marron Brown	RAL 8014	m ² *		
PD.040CA08	Azul Azul Bleu Blue	RAL 5010	m ² *		
PD.040CA09	Vermelho Rojo Rouge Red	RAL 3000	m ² *		

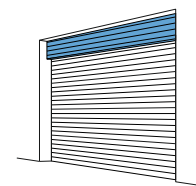

Padieira em painel Canelado Alumínio, incluída na porta Dintel de panel Acanalado Aluminio, suministrado con la puerta Lintheu en panneau Rainuré Aluminium, inclus dans la porte Fascia of Ribbed Aluminium panel, included with door				Opção, Acabamento pintado Opción, Acabado pintado Option, Finition peint Option, Painted finishing	
PD.040CAA0	Branco Blanco Blanc White	RAL 9030	m ² *	PD.040CAA9	Catálogo RAL (1 face) Carta RAL (1 cara) Nuancier RAL (1 face) RAL colour chart (1 side)
PD.040CAA1	Branco Blanco Blanc White	RAL 9030	m ² *	PD.040CAA8	Afinação por amostra (1 face) Afinación por muestra (1 cara) Afination par échantillon (1 face) Sampled colour (1 side)

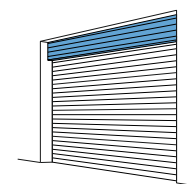

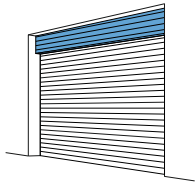

Padieira em painel Canelado Liso lacado, incluída na porta Dintel de panel Acanalado Liso lacado, suministrado con la puerta Linteau en panneau Rainuré Lisse laqué, inclus dans la porte Fascia of Ribbed Super Flat panel powdercoated, included with door					
PD.040CA13 PD.040CA14	Imitação de madeira clara/escura Imitación de madera clara/oscura Imitation bois clair/foncé Light/Dark timber coated design		m ² *		
PD.040CA73 PD.040CA74	Imitação de madeira clara/escura, 2 faces Imitación de madera clara/oscura, 2 caras Imitation bois clair/foncé, 2 faces 2-sided light/dark timber coated design		m ² *		

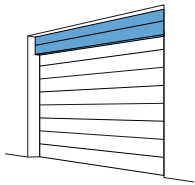

Padieira em painel Friso Único Woodgrain, incluída na porta Dintel de panel Unicanalado Woodgrain, suministrado con la puerta Linteau en panneau Mono Ligne Woodgrain, inclus dans la porte Fascia of Centre Ribbed Woodgrain panel, included with door				Opção, Acabamento pintado Opción, Acabado pintado Option, Finition peint Option, Painted finishing		
PD.040CA40	Branco Blanco Blanc White	RAL 9010	m ² *	PD.040CA49	Catálogo RAL (1 face) Carta RAL (1 cara) Nuancier RAL (1 face) RAL colour chart (1 side)	m ² *
				PD.040CA48	Afinação por amostra (1 face) Afinación por muestra (1 cara) Afnation par échantillon (1 face) Sampled colour (1 side)	m ² *

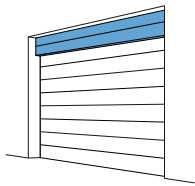

Padieira em painel Friso Único Liso, incluída na porta Dintel de panel Unicanalado Liso, suministrado con la puerta Linteau en panneau Mono Ligne Lisse, inclus dans la porte Fascia of Centre Ribbed Super Flat panel, included with door				Opção, Acabamento pintado Opción, Acabado pintado Option, Finition peint Option, Painted finishing		
PD.040CA30	Branco Blanco Blanc White	RAL 9010	m ² *	PD.040CA79	Catálogo RAL (1 face) Carta RAL (1 cara) Nuancier RAL (1 face) RAL colour chart (1 side)	m ² *
PD.040CA33 PD.040CA34	Imitação de madeira clara/escura Imitación de madera clara/oscura Imitation bois clair/foncé Light/Dark timber coated design		m ² *	PD.040CA78	Afinação por amostra (1 face) Afinación por muestra (1 cara) Afnation par échantillon (1 face) Sampled colour (1 side)	m ² *

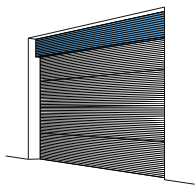

Padieira em painel Micro-friso, incluída na porta Dintel de panel Microacanalado, suministrado con la puerta Linteau en panneau Micronervuré, inclus dans la porte Fascia of Micro Ribbed panel, included with door				Opção, Acabamento pintado Opción, Acabado pintado Option, Finition peint Option, Painted finishing		
PD.040MA00	Branco Blanco Blanc White	RAL 9010	m ² *	PD.040MA99	Catálogo RAL (1 face) Carta RAL (1 cara) Nuancier RAL (1 face) RAL colour chart (1 side)	m ² *
				PD.040MA98	Afinação por amostra (1 face) Afinación por muestra (1 cara) Afnation par échantillon (1 face) Sampled colour (1 side)	m ² *

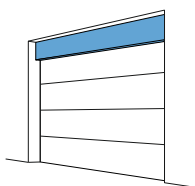

Padieira em painel Liso Liso, incluída na porta Dintel de panel Liso Liso, suministrado con la puerta Linteau en panneau Lisse Lisse, inclus dans la porte Fascia of Super flat panel, included with door				Opção, Acabamento pintado Opción, Acabado pintado Option, Finition peint Option, Painted finishing		
PD.040CA20	Branco Blanco Blanc White	RAL 9010	m ² *	PD.040CA89	Catálogo RAL (1 face) Carta RAL (1 cara) Nuancier RAL (1 face) RAL colour chart (1 side)	m ² *
PD.040CA23 PD.040CA24	Imitação de madeira clara/escura Imitación de madera clara/oscura Imitation bois clair/foncé Light/Dark timber coated design		m ² *	PD.040CA88	Afinação por amostra (1 face) Afinación por muestra (1 cara) Afnation par échantillon (1 face) Sampled colour (1 side)	m ² *

Padieira em painel LM Alu, com acrílico simples incluída na porta
Dintel de panel LM Alu, con acrílico simple suministrado con la puerta
Linteau en panneau LM Alu avec plexiglas simple, inclus dans la porte
Countertop in LM Alu panel, with single acrylic included in the door

Grelha de ventilação em alumínio, para padieira LM Alu
Rejilla de ventilación de aluminio, para dintel LM Alu
Grille de ventilation en aluminium, pour Linteau LM Alu
Aluminium ventilation grid, for LM Alu Countertop

PD.040CAAL	Lacado, catálogo RAL (2 faces) Lacado, carta RAL (2 caras) Laqué, nuancier RAL (2 faces) Powdercoated, RAL colour chart (2 sides)	m ² *	Lacado, catálogo RAL (2 faces) Lacado, carta RAL (2 caras) Laqué, nuancier RAL (2 faces) Powdercoated, RAL colour chart (2 sides)	Preço sob consulta Precio a consultar Prix sur demande Price on request
------------	--	------------------	--	--

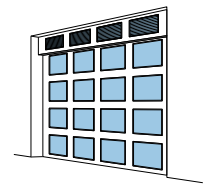

Padieira em painel sablé
Dintel de panel sablé
Linteau en panneau sablé
Countertop in sablé

PD.040CA28	Painel sablé noir Panel sablé noir Panneau sablé noir Sablé panel noir	m ² *		
PD.040CA25	Painel sablé Panel sablé Panneau sablé Sablé panel	m ² *		

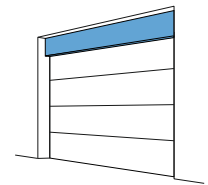

Padieira em painel silver
Dintel de panel silver
Linteau en panneau silver
Countertop in silver

PD.040CA91	Painel silver Panel silver Panneau silver Silver panel	m ² *		
------------	---	------------------	--	--

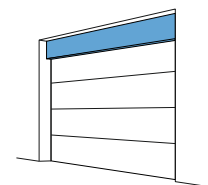

Padieira em painel inox
Dintel de panel corten
Linteau en panneau corten
Countertop in corten

PD.040CA94	Painel inox Panel inox Panneau inox Inox panel	Imitação inox escovado Imitación de acero inoxidable cepillado Imitation acier inoxydable brossé Brushed stainless steel imitation	m ² *	
------------	---	---	------------------	--

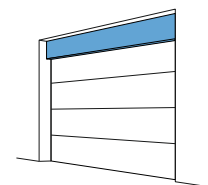

Padieira em painel corten
Dintel de panel corten
Linteau en panneau corten
Countertop in corten

PD.040CA93	Painel corten Panel corten Panneau corten Corten panel	Imitação de aço corten Imitación de acero corten Imitation acier corten Corten steel imitation	m ² *	
------------	---	---	------------------	--

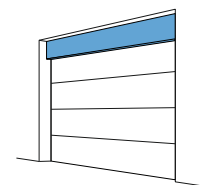

Perfil de padieira de alumínio em U
Perfil para dintel de alumínio en forma de U
Rail pour linteau en aluminium en forme de U
U-shaped aluminium lintel rail

03.510305	Perfil de alumínio em U branco Perfil de alumínio en forma de U blanco Rail en aluminium en forme de U blanc U-shaped aluminium rail white	ml		
03.501317	Perfil de alumínio em U Preto Perfil de alumínio en forma de U negro Rail en aluminium en forme de U noir U-shaped aluminium rail black	ml		
03.501309	Perfil de alumínio em U RAL Perfil de alumínio en forma de U RAL Rail en aluminium en forme de U RAL U-shaped aluminium rail RAL	ml		

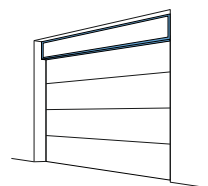

› CONFIGURAÇÃO DE PORTAS ECLIPSE

CONFIGURACIÓN DE LA PUERTA ECLIPSE | CONFIGURATION DE LA PORTE ECLIPSE | DOOR CONFIGURATION ECLIPSE

MAX. 5x3m

Min. 80mm

Padieira / Dintel / Lindeau / Headroom

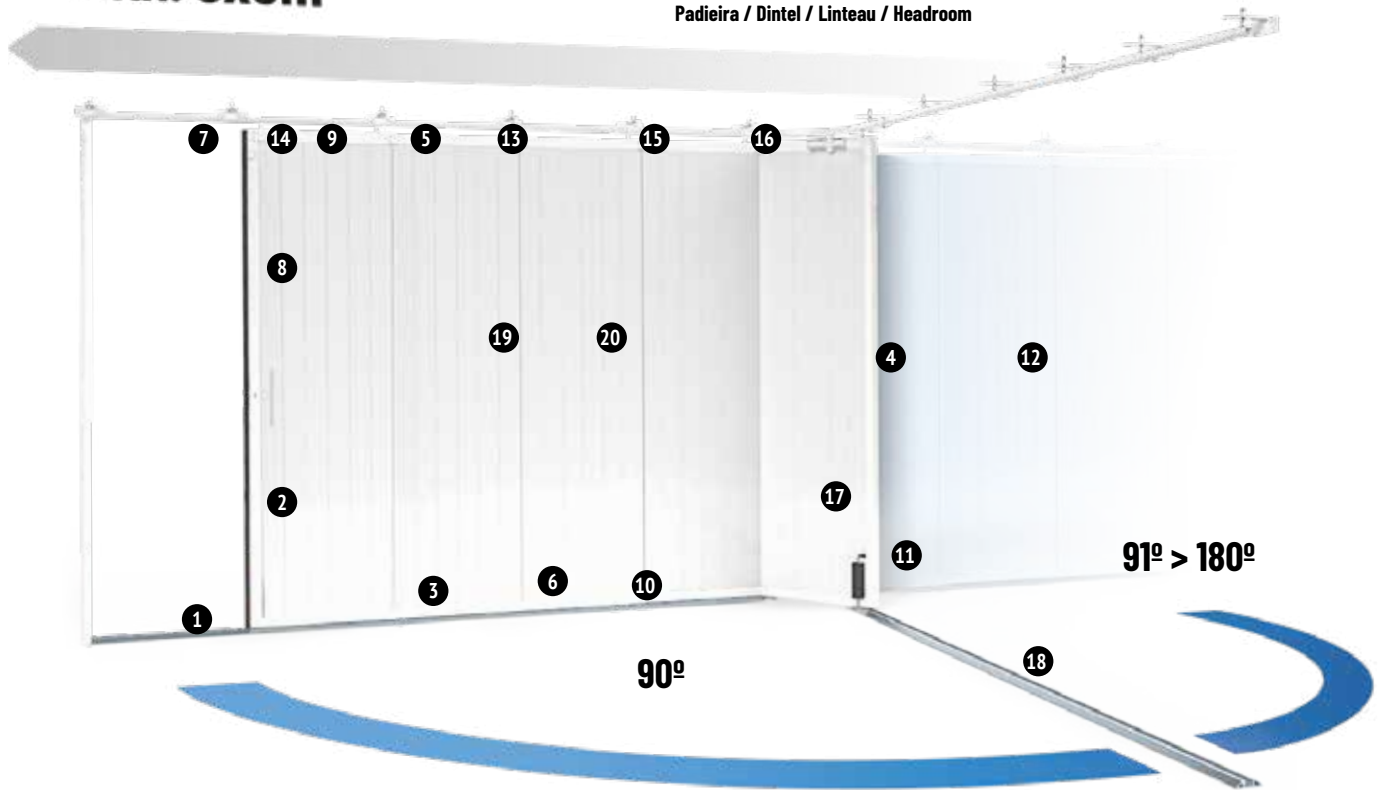

Min. 150mm

Ombreira / Marco / Écoinçon / Jamb

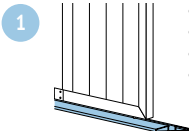

- Guia inferior de rampa dupla, em alumínio extrudido
- Guía inferior en rampa doble, de aluminio extrudido
- Guide inférieur à double rampe, en aluminium extrudé
- Double ramp floor track, of extruded aluminium

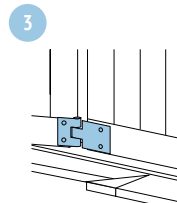

- Dobradiças centrais em aço galvanizado com ponto de lubrificação
- Bisagras intermedias de acero galvanizado con ojete de lubricación
- Charnières centrales en acier galvanisé et point de lubrification
- Central hinges of galvanized steel with lubrication point

Opção: acabamento lacado
 Opción: acabado lacado
 Option: finition laquée
 Option: powdercoated finishing

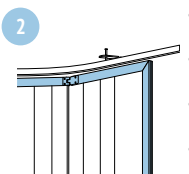

- Perfil de alumínio reforçado, termo-lacado e pintado à cor do painel, em todo o perímetro da porta
- Perfil de aluminio reforzado, termolacado y pintado en el color del panel
- Profil en aluminium renforcé, thermo-laqué et peint à la couleur du panneau, autour du périmètre de la porte
- Reinforced aluminium profile, powdercoated and painted with the panels colour, all edges

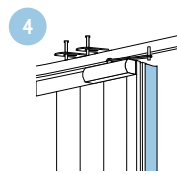

- Vedante traseiro em EPDM preto e mola de fecho montada no último painel, para um fecho seguro e maior estanquidade
- Goma trasera de EPDM negro y cierrapuertas acoplado en el último panel, para mejor estanquidad y seguridad cuando cerrada
- Joint d'étanchéité arrière en EPDM noir et ferme-porte posé sur le dernier panneau, pour une meilleure étanchéité et sécurité de la fermeture
- Back seal of black EPDM and doorcloser over the end panel, for best tightness and closing

5

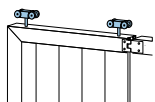

- Carrinhos em aço galvanizado com rodas em nylon, para um movimento silencioso na guia superior
- Soportes rodantes de acero galvanizado con ruedas de nylon, para un desplazamiento silencioso en la guía superior
- Chariots en acier galvanisé avec roulettes en nylon, pour un mouvement silencieux du guide supérieur
- Galvanized steel hangers with silent running nylon wheels

6

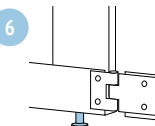

- Guiamento na guia inferior por rolamentos de esferas em aço
- Guidores inferiores con rodamientos de bolas en acero
- Guide vertical et rails en acier galvanisé
- Floor track guiders with steel ball bearings

7

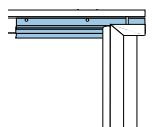

- Vedante superior em PVC vulcanizado preto, montado em suporte na padieira
- Goma superior de PVC vulcanizado negro, montado en soporte en el dintel
- Joints supérieurs en PVC vulcanisé noir, posé sur support dans le linteau
- Top seal of vulcanized black PVC, applied in support over headroom

Opção: suporte com acabamento lacado
 Opción: soporte lacado
 Option: support laqué
 Option: powdercoated support

8

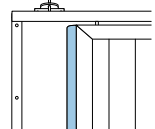

- Vedante frontal longo em EPDM preto, com batente em aço galvanizado
- Goma frontal largo de EPDM negro, con batiente de acero galvanizado
- Joint d'étanchité frontal long en EPDM noir et battant en acier galvanisé
- Front seal of black EPDM with door stopper of galvanized steel

Opção: batente com acabamento lacado
 Opción: battiente lacado
 Option: battant laquée
 Option: powdercoated door stopper

9

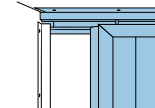

- Batente de vedante frontal em aço galvanizado, lacado e pintado à cor do painel
- Batiente de goma frontal, de acero galvanizado, lacado y pintado a la color del panel
- Battant de joint d'étanchité frontal, en acier galvanisé, laqué et peint à la couleur du panneau
- Front seal door stopper, of galvanized steel, powdercoated and painted same as panel colourjoint

10

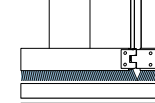

- Vedante inferior de escova em polipropileno
- Goma inferior de escobilla de polipropileno
- Joint brosse inférieur en polypropylène
- Bottom brush seal of polypropylene

11

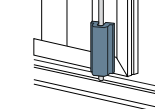

- Trinco traseiro em aço galvanizado com veio redondo maciço
- Cerrojo de acero galvanizado con eje redondo macizo
- Verrou arrière en acier galvanisé avec un axe massif
- Solid round bar floor bolt, galvanized steel

12

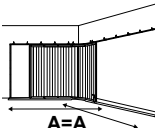

- Profundidade mínima do local de aplicação igual à largura do vão
- Profundidad mínima del espacio de instalación igual al ancho del hueco
- Refoulement minimum doit être égal à la largeur entre baie
- Minimum depth of installation site must be the same as the opening width

13

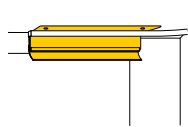

- Guia superior em suporte 'L', em aço galvanizado, aplicada directamente ao tecto
- Guía superior en soporte 'L', de acero galvanizado, para montaje directo en el techo
- Guide supérieur sur support 'L', en acier galvanisé, pour appliée directement sur plafond
- Top track on 'L' support, of galvanized steel, directly applied to ceiling

Opção: acabamento lacado
 Opción: acabado lacado
 Option: finition laquée
 Option: powdercoated finishing

14

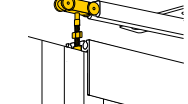

- Ajustagem directamente no veio do carrinho
- Ajustación directa por el eje del soporte rodante
- Réglage directement sur l'axe du charriot
- Tuning of the door directly over hangers axle

15

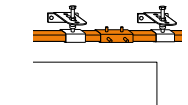

- Guia superior repartida com suportes e uniões, em aço galvanizado
- Guía superior repartida y con acoplamientos, de acero galvanizado
- Guide supérieur réparti et avec des unions, en acier galvanisé
- Top track splitted and with couplers, of galvanized steel

Opção: acabamento lacado
 Opción: acabado lacado
 Option: finition laquée
 Option: powdercoated finishing

16

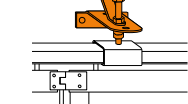

- Suportes de guia superior com ajustagem total, em aço galvanizado
- Soportes de guía superior con ajustación total, de acero galvanizado
- Supports du guide supérieur totalment réglables, en acier galvanisé
- Top track brackets with full tuning, of galvanized steel

Opção: acabamento lacado
 Opción: acabado lacado
 Option: finition laquée
 Option: powdercoated finishing

17

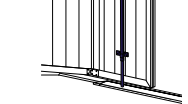

- Fechadura de segurança tipo 'FAC' em aço galvanizado
- Cerradura de seguridad tipo 'FAC', de acero galvanizado
- Serrure de sécurité type 'FAC' en acier galvanisé
- 'FAC' type security lock of galvanized steel

18

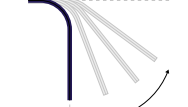

- Curvatura da guia superior e esquadria da guia inferior feitas por medida (sem stock)
- Curvatura de la guía superior y esquadria de la guía inferior hechas por medida (sin stock)
- Courbure du rail supérieur et équerage du rail inférieur exécuté sur mesure (sans stock)
- Curvature of top track and frame cut of floor track only by order (no stock)

19

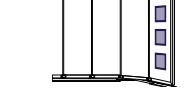

- Janelas em vidro, visores em policarbonato e ventiladores em alumínio e PVC
- Mirillas de vidrio o policarbonato y ventiladores de aluminio o PVC
- Hublots de verre ou polycarbonate et grilles de ventilation en aluminium et PVC
- Glass or polycarbonate windows and ventilation grids of aluminium or PVC

20

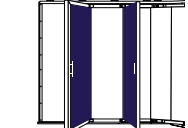

- Porta-homem embutida no portão
- Puerta peatonal insertada en el portón
- Portillon encastré dans la porte
- Built-in wicket door

Opção: porta-homem no meio do portão
 Opción: puerta peatonal en el medio del portón
 Option: porte piétonne au centre du portail
 Option: wicket door at the middle of the gate

➤ CONFIGURAÇÃO DE MOTORIZAÇÃO ECLIPSE

CONFIGURACIONES DE MOTORIZACIÓN " ECLIPSE " | CONFIGURATIONS DE MOTORISATION " ECLIPSE " | AUTOMATED DOOR CONFIGURATION " ECLIPSE "

- Motorização com motor de arrasto, de alta sensibilidade a quaisquer obstáculos
- Motorización con motor de techo, con gran sensibilidad a cualesquier obstáculos
- Motorisation avec moteur tirant, de haute sensibilité à tous les obstacles
- Automated with ceiling operator, high level of sensitivity to obstacles

Tipo 1

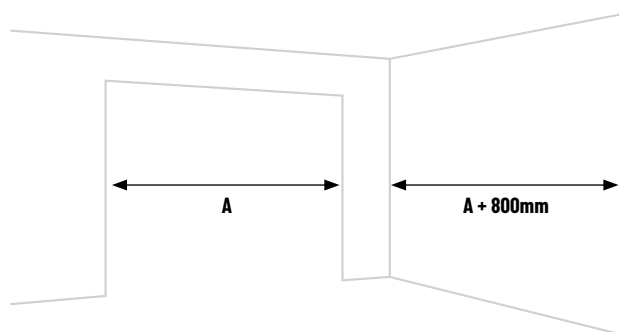
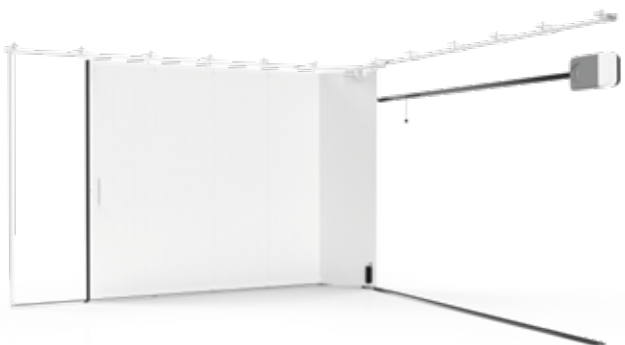

Tipo 2

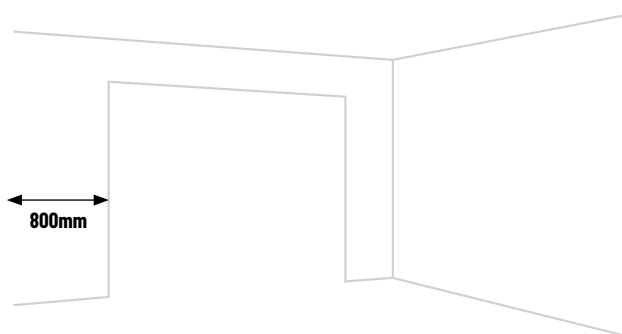
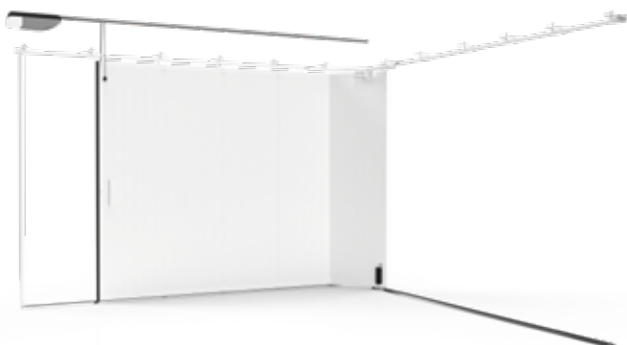

Tipo 3

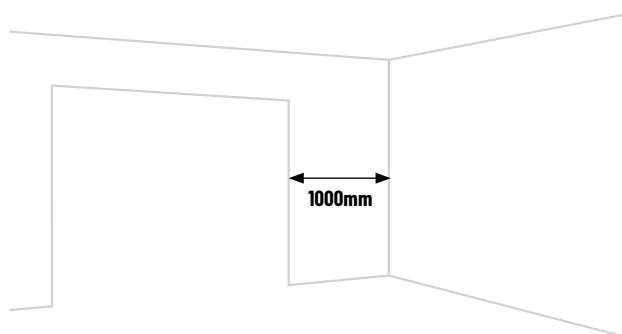
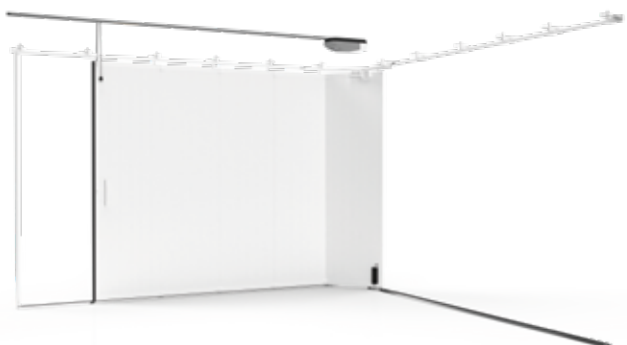

OPÇÕES E ACESSÓRIOS PORTÕES ECLIPSE

OPCIONES Y RECAMBIOS PUERTAS ECLIPSE | OPTIONS ET ACCESSOIRES PORTES ECLIPSE | OPTIONS AND SPARES ECLIPSE DOORS

Calha superior em aço galvanizado, incluída na porta Guía superior de acero galvanizado, suministrada con la puerta Rail supérieur en acier galvanisé, inclus dans la porte Top track of galvanized steel, included in the door		Opção, Calhas e ferragem Opción, Guías y herraje Option, Rails et ferrures Option, Tracks and hardware	
PL.900010	Calha com curvatura entre 91° e 179° Guía con curvatura de 91° hasta 179° Rail avec courbure de 91° jusqu'à 179° Track curved from 91° to 179°	uni *	NS.GL
			Calha superior lacada, aço galvanizado Guía superior lacada, acero galvanizado Rail supérieur laqué, acier galvanisé Powdercoated top track, galvanized steel
			NS.FL
			Ferragem lacada, aço galvanizado Herraje lacado, acero galvanizado Ferrures laqués, acier galvanisé Powdercoated hardware, galvanized steel

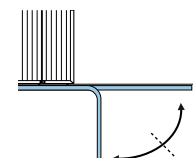

Fechadura tipo 'FAC', incluída na porta Eclipse Cerradura de seguridad tipo 'FAC', suministrada con la puerta Eclipse Serrure de sécurité type 'FAC', inclus dans la porte Eclipse 'FAC' type security lock, included in the Eclipse door			
NS.230330	Fechadura de segurança tipo 'FAC' / Eclipse Cerradura de seguridad tipo 'FAC' / Eclipse Serrure de sécurité type 'FAC' / Eclipse 'FAC' type security lock/ Eclipse	uni	

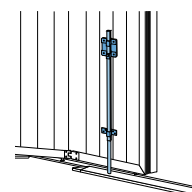

Fechadura 2 pontos vertical Cerradura 2 puntos vertical Serrure 2 points vertical Top and bottom vertical lock		Acessórios para fechaduras Accesorios para cerraduras Accessoires pour serrures Locks paraphernalia	
03.509400	Fechadura vertical com canhão europeu Cerradura vertical com bombillo europeo Serrure vertical avec cylindre européen Vertical lock with europrofile cylinder	uni	03.230343
			Canhão 30/30 e 3 chaves Bombillo 30/30 y 3 llaves Cylindre 30/30 et 3 clés Cylinder 30/30 and 3 keys
			03.230999
			Chave extra (fechadura de 6 pinos) Llave extra (cerradura de 6 pines) Clé extra (serrure à 6 goupilles) Extra key (6 pin lock)

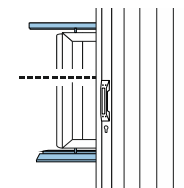

Terminais de acabamento de guia de chão, em PVC preto Topes de finalización de guía del suelo, de PVC negro Montants de finition de guide de sol, en PVC noir Floor's rail end tops, of black PVC			
03.509197	Terminal esquerdo de guia Tope izquierdo de la guía Montant gauche de guide Rail's top end, left-hand	uni	
03.509198	Terminal direito de guia Tope derecho del macho Montant droit de guide Rail's top end, right-hand	uni	

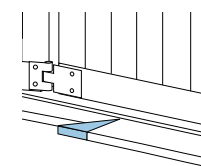

Guiamento superior da porta Guiamiento superior de la puerta Guidage supérieur de la porte Door's hang running		Guiamento superior + inferior da porta Guiamiento superior + inferior de la puerta Guidage supérieur + inférieur de la porte Door's hang running and bottom guidance	
03.509102	Carrinho superior com veio Soporte rodante con eje Charriot avec arbre Hanger with axle	uni	03.509110
			Carrinho superior + guiador inferior Soporte rodante + guiador inferior Charriot + guidon inférieur Hanger + bottom guider

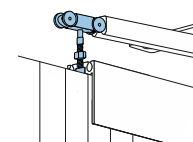

Guiamento inferior da porta Guiamiento inferior de la puerta Guidage inférieur de la porte Door's bottom guidance			
03.509117	Guiador inferior com veio Guiador inferior con eje Guidon inférieur avec arbre Bottom guider with axle	uni	

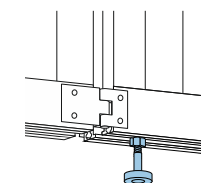

VISORES

MIRILLAS | HUBLOTS | GLAZING

VIDROS E ACRÍLICOS

VIDRIO Y ACRÍLICO | VERRE ET ACRYLIQUE | GLASS AND ACRYLIC



Vidro e acrílico transparente
 Vidrio y acrílico transparente
 Verre et acrylique transparent
 Clear glass and acrylic



Vidro e acrílico fosco, branco
 Vidrio y acrílico translúcido, blanco
 Verre et acrylique opaque, blanc
 White frosted glass and acrylic



Vidro e acrílico impresso
 Vidrio y acrílico granulado
 Verre et acrylique granité
 Hammered glass and acrylic



Vidro espelhado
 Vidrio espejado
 Verre miroité
 Mirrored glazing

VISORES DE VIDRO

MIRILLA VIDRIO | HUBOLT VERRE | GLASS GLAZING



505x305mm
 Visor simples
 Mirilla transparente
 Hublot transparent
 Plain glazing



505x305mm
 Visor "Losango"
 Mirilla "Losango"
 Hublot "Losango"
 "Losango" glazing



505x305mm
 Visor "Losango", im. madeira escura
 Mirilla "Losango", im. madeira escura
 Hublot "Losango", im.bois foncé
 "Losango" glazing, dark wood imitation



505x305mm
 Visor "Losango", im. madeira clara
 Mirilla "Losango", im. madeira clara
 Hublot "Losango", im.bois clair
 "Losango" glazing, light wood imitation



505x305mm
 Visor "Colonial"
 Mirilla "Colonial"
 Hublot "Colonial"
 "Colonial" glazing



505x305mm
 Visor "Colonial", im. madeira escura
 Mirilla "Colonial", im. madeira escura
 Hublot "Colonial", im.bois foncé
 "Colonial" glazing, dark wood imitation



505x305mm
 Visor "Colonial", im. madeira clara
 Mirilla "Colonial", im. madeira clara
 Hublot "Colonial", im.bois clair
 "Colonial" glazing, light wood imitation



505x305mm
 Visor "Colonial", Dourado fino
 Mirilla "Colonial", Dorado fino
 Hublot "Colonial", Doré fin
 "Colonial" glazing, Narrow gold

VISORES ACRÍLICOS

MIRILLAS ACRÍLICAS | HUBOLT ACRYLIQUE | ACRYLIC GLAZING



505x305mm
 Visor simples
 Mirilla transparente, branco
 Hublot transparent, blanc
 Clear glazing, white



320x155mm
 Visor transparente, branco
 Mirilla transparente, branco
 Hublot transparent, blanc
 Clear glazing, white



318mm Ø
 Visor transparente, branco
 Mirilla transparente, branco
 Hublot transparent, blanc
 Clear glazing, white



290x290mm
 Visor transparente, branco
 Mirilla transparente, branco
 Hublot transparent, blanc
 Clear glazing, white



290x290mm
 Visor transparente, im. madeira escura
 Mirilla transparente, im. madeira escura
 Hublot transparent, im.bois foncé
 Clear glazing, dark wood imitation



290x290mm
 Visor transparente, im. madeira clara
 Mirilla transparente, im. madeira clara
 Hublot transparent, im.bois clair
 Clear glazing, light wood imitation



290x290mm
 Visor transparente, cromado
 Mirilla transparente, cromado
 Hublot transparent, chrome
 Clear glazing, chrome



726x326mm
 Visor industrial grande
 Mirilla industrial grande
 Grand hublot industriel
 Big industrial window



638x206mm
 Visor industrial estreito
 Mirilla industrial estrecha
 Grand hublot industriel étroit
 Slim industrial window



330mm Ø
 Visor industrial redondo
 Mirilla industrial redonda
 Hublot industriel rond
 Round industrial window



VISORES DE ALUMÍNIO E AÇO INOX

MIRILLA DE ALUMINIO Y ACERO INOXIDABLE | HUBLOTS EN ALUMINIUM ET EN ACIER INOXYDABLE | ALUMINIUM AND STAINLESS STEEL SIGHT



Visor de alumínio lacado
Mirilla de alumínio lacado
Hublot en aluminium laqué
Lacquered aluminium window

Visor com tamanho máximo de 1500x300mm, lacado à cor da porta. Preço sob consulta
 Expositor con un tamaño máximo de 1500x300mm, lacado en el color de la puerta. Precio a petición
 Présentoir d'une dimension maximale de 1500x300mm, laqué dans la couleur de la porte. Prix sur demande
 window with a maximum size of 1500x300mm, powder-coated in accordance with the door's colour. Price on request



290x290mm
 Visor alumínio, fosco
 Mirilla aluminio, translucido
 Hublot aluminium, opaque
 Aluminium, frosted



310x310mm
 Visor aço inox, transparente
 Mirilla acero inox, transparente
 Hublot inox, transparent
 Stainless steel, transparent





330mm Ø
 Visor aço inox, transparente
 Mirilla acero inox, transparente
 Hublot inox, transparent
 Stainless steel window, transparent

➤ VISORES E VENTILADORES



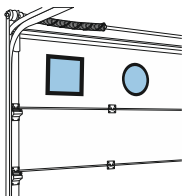



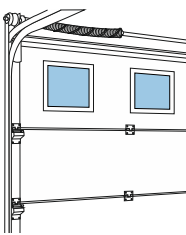

MIRILLAS Y VENTILADORES | HUBLOTS ET GRILLES | GLAZING AND VENTILATION

- Os visores de vidro ou acrílico são de lâmina dupla e incluem caixilho
- Las mirillhas de vidrio o acrílico tienen lama doble y son suministrados con marco
- Les hublots de verre ou acrylique son de double lame et incluent encadrement
- Glazing glasses or acrylics are double sheeted and with frame included







Visor de vidro, metálico incluído na porta Mirilla de vidrio, metálica incluida en la puerta Hublot de verre, en métal inclus dans la porte Glass glazing, metal frame included in the door			
NS.606135	Visor em inox, redondo de vidro claro Mirilla inox, redonda con cristal transparente Hublot rond en inox, avec verre lisse Stainless steel, transparent round glazing	 Ø 330mm	uni.
NS.606231	Visor em inox, quadrado de vidro claro Mirilla inox, cuadrado con cristal transparente Hublot carré en inox, avec verre lisse Stainless steel, transparent square glazing	 310x310mm	uni.
NS.610110	Visor alumínio, quadrado de vidro fosco Mirilla aluminio, cuadrado con cristal translucido Hublot aluminium, verre opaque carré Aluminium, frosted glass square glazing	 290x290mm	uni.

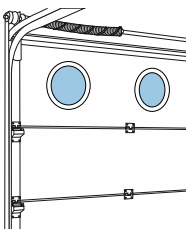



Visor quadrado de acrílico liso Mirilla cuadrado de acrílico liso Hublot carré d'acrylique lisse Square plain acrylic glazing				Visor quadrado de acrílico impresso Mirilla cuadrado de acrílico granulado Hublot carré d'acrylique granité Square figured acrylic glazing			
NS.611011	branco blanco blanc white RAL 9010	 290x290mm	uni.	NS.611012	branco blanco blanc white RAL 9010	 290x290mm	uni.
NS.611021	cromado cromado chrome chrome	 290x290mm	uni.	NS.611022	cromado cromado chrome chrome	 290x290mm	uni.
NS.611031	Imitação de madeira clara Imitación de madera clara Imitation bois clair Light timber coated design	 290x290mm	uni.	NS.611032	Imitação de madeira clara Imitación de madera clara Imitation bois clair Light timber coated design	 290x290mm	uni.
NS.611041	Imitação de madeira escura Imitación de madera oscura Imitation bois foncé Dark timber coated design	 290x290mm	uni.	NS.611042	Imitação de madeira escura Imitación de madera oscura Imitation bois foncé Dark timber coated design	 290x290mm	uni.





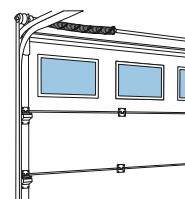





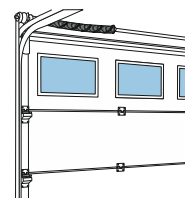



Visor redondo de acrílico liso Mirilla redonda de acrílico liso Hublot rond d'acrylique lisse Round plain acrylic glazing			
NS.612001	branco blanco blanc white RAL 9010	 Ø 318mm	uni.

Visor simples de vidro incluído na porta Mirilla de vidrio liso, suministrado con la puerta Hublot de verre lisse, inclus dans la porte Plain glass glazing, included with door				Visor simples de vidro incluído na porta Mirilla de vidrio liso, suministrado con la puerta Hublot de verre lisse, inclus dans la porte Plain glass glazing, included with door			
NS.606107	Vidro transparente Vidrio transparente Verre transparent Transparent glass		505x305mm uni.	NS.606104	Vidro espelhado Vidrio espejado Verre miroité Mirror glass		505x305mm uni.
				NS.606105	Vidro impresso Vidrio granulado Verre granité Figured glass		505x305mm uni.
				NS.606125	Visor laminado fosco Mirilla laminado translúcido Hublot laminé opaque Frosted laminated glazing		505x305mm uni.







Visor simples de acrílico, incluído na porta Mirilla liso de acrílico, suministrado con la puerta Hublot lisse d'acrylique, inclus dans la porte Plain acrylic glazing, included with door							
NS.606300	Visor transparente Mirilla transparente Hublot transparent Transparent glazing		505x305mm uni.				
NS.606310	Visor transparente Mirilla transparente Hublot transparent Transparent glazing		320x154mm uni.				

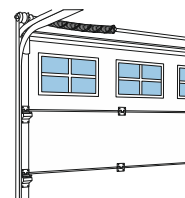

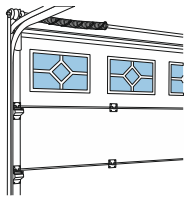





Visor de vidro transparente 'Colonial', incluído na porta Mirilla de vidrio transparente 'Colonial', suministrado con la puerta Hublot de verre transparent 'Colonial', inclus dans la porte Transparent glass 'Colonial' glazing, included with door				Visor de vidro impresso 'Colonial', incluído na porta Mirilla de vidrio granulado 'Colonial', suministrado con la puerta Hublot de verre granité 'Colonial', inclus dans la porte Figured glass 'Colonial' glazing, included with door			
NS.606108	Branco Blanco Blanc white	RAL 9010	 505x305mm uni.	NS.606106	Branco Blanco Blanc White	RAL 9010	 505x305mm uni.
NS.606120	Crema Crema Beige Cream	RAL 1015	 505x305mm uni.	NS.606117	Crema Crema Beige Cream	RAL 1015	 505x305mm uni.
NS.606121	Cinza Gris Gris Grey	RAL 9006	 505x305mm uni.	NS.606118	Verde Verde Vert Green	RAL 6005	 505x305mm uni.
NS.606109	Verde Verde Vert Green	RAL 6005	 505x305mm uni.				
NS.606110	Castanho Marrón Marron Brown	RAL 8014	 505x305mm uni.				
NS.606129	Imitação de madeira clara Imitación de madera clara Imitation bois claire Timber coated design, light		 505x305mm uni.				
NS.606130	Imitação de madeira escura Imitación de madera oscura Imitation bois foncé Timber coated design dark		 505x305mm uni.				
NS.606119	Dourado fino Dorado fino Doré fin Narrow golden		 505x305mm uni.				

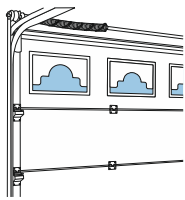





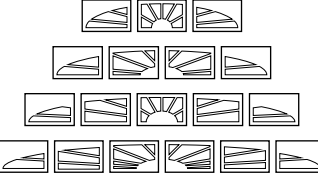

Visor de vidro transparente 'Losango', incluído na porta Mirilla de vidro transparente 'Losango', suministrado con la puerta Hublot de verre transparent 'Losango', inclus dans la porte Transparent glass 'Losango' glazing, included with door					Visor de vidro impresso 'Losango', incluído na porta Mirilla de vidro granulado 'Losango', suministrado con la puerta Hublot de verre granité 'Losango', inclus dans la porte Figured glass 'Losango' glazing, included with door				
NS.606206	Branco Blanco Blanc white	RAL 9010	 505x305mm	uni.	NS.606212	Branco Blanco Blanc White	RAL 9010	 505x305mm	uni.
NS.606209	Imitação de madeira clara Imitación de madera clara Imitation bois clair Light timber coated design		 505x305mm	uni.					
NS.606210	Imitação de madeira escura Imitación de madera oscura Imitation bois foncé Dark timber coated design		 505x305mm	uni.					

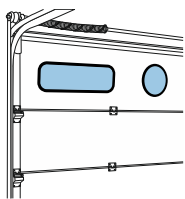

Visor de vidro montado com desenho, incluído na porta Mirilla de vidro montado con diseño, suministrado con la puerta Hublot de verre assemblé avec dessin, inclus dans la porte Glazing glass with cover design applied, included with door					Desenho em PVC branco para visor de vidro Diseño de PVC blanco para mirilla de vidro Dessin en PVC blanc pour hublot de verre Glazing glass cover design of white PVC				
NS.606111	Vidro transparente com desenho Vidrio transparente con diseño Hublot transparent avec dessin Transparent glass with cover design		 505x305mm	uni.	'Arcada' 'Arcada' (galeria) 'Arcada' (galerie) 'Arcada' (arcade)				
NS.606112	Vidro impresso com desenho Vidrio granulado con diseño Hublot granité avec dessin Figured glass with cover design		 505x305mm	uni.	'Catedral' 'Catedral' (cathédrale) 'Catedral' (cathedral)				
Visor de acrílico montado com desenho, incluído na porta Mirilla de acrílico montado con diseño, suministrado con la puerta Hublot de acrylique assemblé avec dessin, inclus dans la porte Glazing acrylic with cover design applied, included with door					'Meia-Lua' 'Meia-lua' (media luna) 'Meia-lua' (couché de soleil) 'Meia-lua' (fanlight)				
NS.606301	Visor transparente com desenho Mirilla transparente con diseño Hublot transparent avec dessin Transparent glazing with cover design		 505x305mm	uni.					



Visor de acrílico rectangular industrial, incluído na porta Mirilla acrílico rectangular industrial, suministrado con la puerta Hublot d'acrylique rectangulaire industriel, inclus dans la porte Rectangular industrial acrylic glazing, included with door									
NS.606113	Visor claro grande Mirilla lisa Hublot lisse Plain glazing		 726x326mm	uni.					
NS.606114	Visor claro estreito Mirilla lisa Hublot lisse Plain glazing		 638x206mm	uni.					
Visor de acrílico redondo industrial, incluído na porta Mirilla acrílico redondo industrial, suministrado con la puerta Hublot d'acrylique rond industriel, inclus dans la porte Round industrial acrylic glazing, included with door									
NS.606115	Visor claro Mirilla lisa Hublot lisse Plain glazing		 Ø 330mm	uni.					

Grelha de ventilação em PVC (int. + ext.), incluído na porta Rejilla de ventilación simple de PVC (int. + ext.), suministrado con la puerta Grille de ventilation simple en PVC (int. + ext.), inclus dans la porte Regular ventilation grid of PVC (int. + ext.), included with door				Grelha de ventilação em PVC (int. + ext.), incluído na porta Rejilla de ventilación simple de PVC (int. + ext.), suministrado con la puerta Grille de ventilation simple en PVC (int. + ext.), inclus dans la porte Regular ventilation grid of PVC (int. + ext.), included with door	
NS.605920	Ventilador branco, simples Ventilador blanco, simple Ventilateur blanc, simple Ventilation grid, white, standard	250x100mm	uni.	NS.605924	Ventilador branco com rede, regulável Ventilador blanco con red, regulable Ventilateur blanc avec réseau, réglable White adjustable ventilation grid with mesh

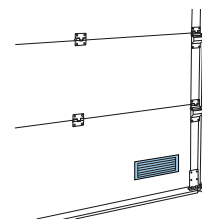

Grelha de ventilação em alumínio, incluído na porta Rejilla de ventilación de aluminio, suministrado con la puerta Grille de ventilation en aluminium, inclus dans la porte Aluminium ventilation grid, included with door					
NS.605910	Ventilador branco com caixilho Ventilador blanco con marco Ventilateur blanc avec encadrement White ventilation grid with frame	505x305mm	uni.		

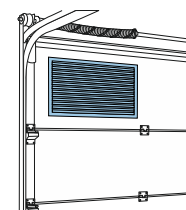

Opção Acabamento de visor e ventilador Opción Acabado de mirilla y ventilador Option Finalisassion de hublot et ventilateur Option Glazing and ventilation finishing					
NS.PINTACC	Pintura RAL de caixilho/desenho/ventilador Pintura RAL de marco/deseño/ventilador Peinture RAL de cadre/dessin/ventilateur RAL painting of frame/cover design/grid		uni.		
NS.AB	Abertura de buraco em painel Apertura de agujero en panel Ouverture d'un trou dans le panneau Opening hole in panel		uni.		
NS.PELÍCULA	Aplicação de película fosco Aplicación de la película translúcida Application du film dépoli Matt film application		uni.		

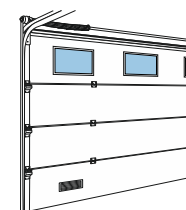

LM PERFIS

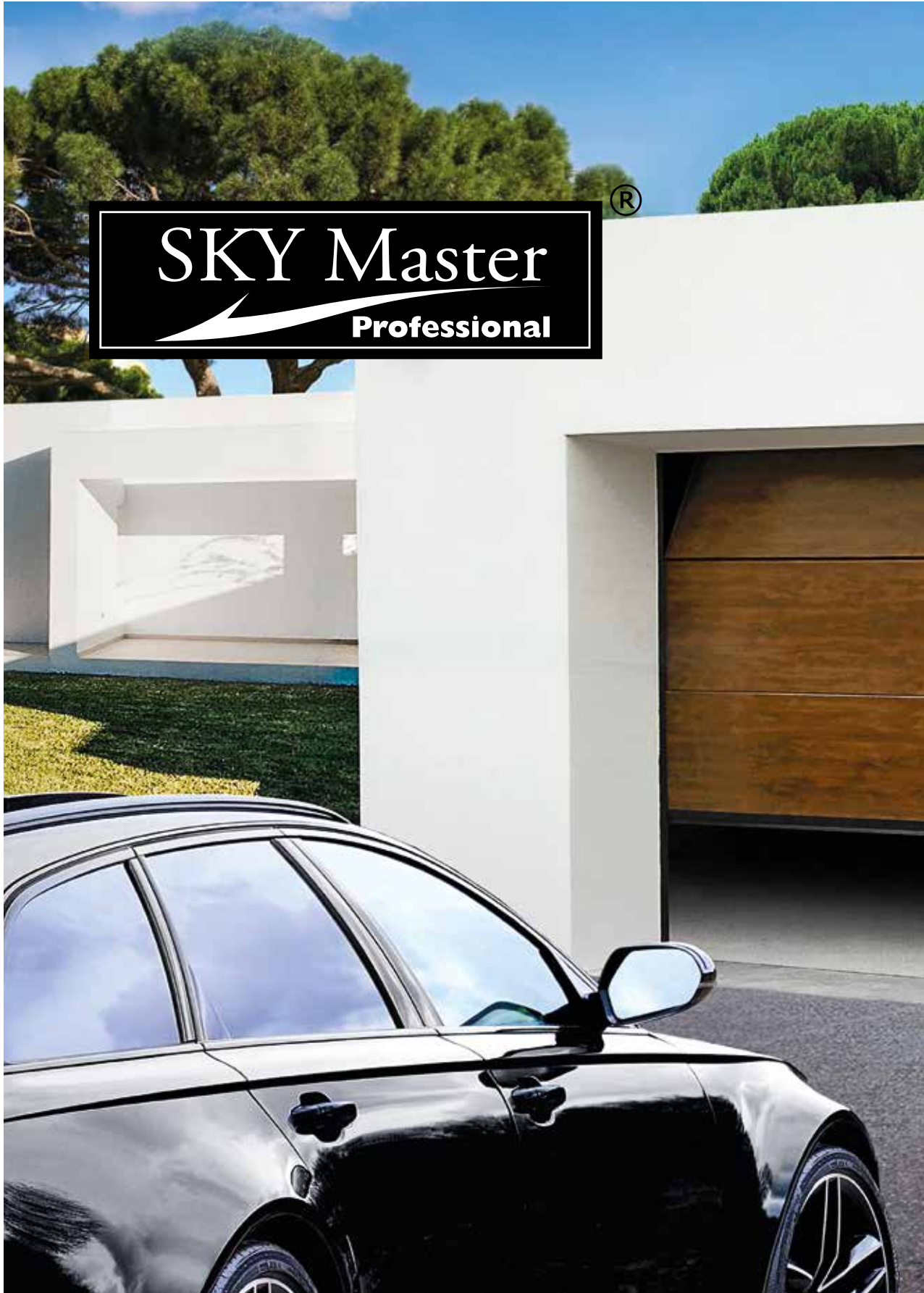

SKY Master[®]
Professional

> AUTOMAÇÃO

AUTOMACIÓN PARA PUERTAS | AUTOMATION POUR PORTES | DOOR AUTOMATION



F-330

MOTOR DE TETO
MOTOR DE TECHO
MOTEUR DE PLAFOND
CEILING MOTOR

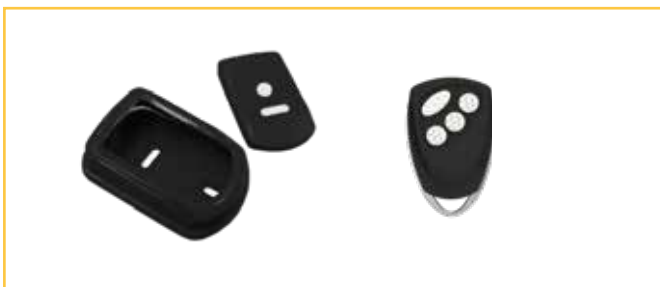

F-330

Alimentação / Alimentación / Alimentation / Power supply	V AC	230
Motor / Motor / Moteur / Motor	V DC	24
Potência / Potencia / Puissance / Power	W	90
Torque / Torque / Moment de force / Torque	N.m	600
Velocidade / Velocidad / Vitesse / Speed	cm/s	11.0
Área máx. da porta / Tamaño máx. de puerta / Taille max. de porte / Max. door size	m ²	8
Fusível / Fusible / Fusible / Fuse	A (2x)	2,5
Modo económico / Stand-by / Mise en veille / Standby	W	4
Temperatura / Temperatura / Temperature / Temperature	°C	-20 - +50
Frequência / Frecuencia / Fréquence / Frequency	MHz	433 (50m)
Luz de cortesia / Luz de cortesía / Éclairage de courtoisie / Courtesy light	(1x)	LED
Placa de controlo / Central de mando / Logique de commande / Control board		integrada / integrada intégrée / integrated

Kit F-330 SkyMaster	Para portas de altura até Para puertas con altura hasta Pour portes de hauteur jusqu'à For door heights up to	Com calha de corrente Con guía de cadena Avec rail à chaîne With chain rail
02.479230	2240mm	kit
02.479233	2540mm	kit

F-350

MOTOR DE TETO
MOTOR DE TECHO
MOTEUR DE PLAFOND
CEILING MOTOR

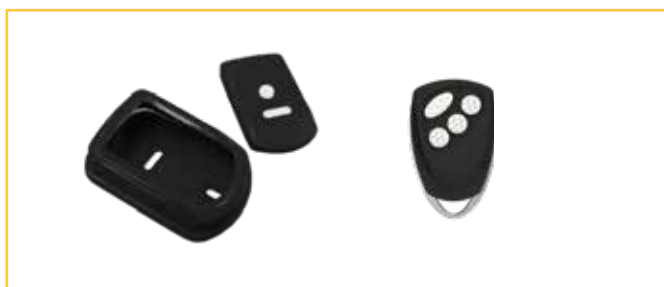

F-350M F-350G

Alimentação / Alimentación / Alimentation / Power supply	V AC	230	230
Motor / Motor / Moteur / Motor	V DC	24	24
Potência / Potencia / Puissance / Power	W	100	150
Intensidade / Absorción / Intensité / Absorption		0.43	0.65
Torque / Torque / Moment de force / Torque	N.m	700	1100
Velocidade / Velocidad / Vitesse / Speed	cm/s	11.0	11.0
Área máx. da porta / Tamaño máx. de puerta / Taille max. de porte / Max. door size	m ²	10	15
Fusível / Fusible / Fusible / Fuse	A (2x)	2.5	2.5
Modo económico / Stand-by / Mise en veille / Standby	W	4	4
Temperatura / Temperatura / Temperature / Temperature	°C	-20 ~ +50	-20 ~ +50
Frequência / Frecuencia / Fréquence / Frequency	MHz	433 (50m)	433 (50m)
Luz de cortesia / Luz de cortesía / Éclairage de courtoisie / Courtesy light	(1x)	LED	LED
Placa de control / Central de mando / Logique de commande / Control board		integrada / integrada intégrée / integrated	

Kit F-350M SkyMaster	Para portas de altura até Para puertas con altura hasta Pour portes de hauteur jusqu'à For door heights up to	Com calha de corrente Con guía de cadena Avec rail à chaîne With chain rail
02.487301	2200mm	kit
02.487331	2500mm	kit
02.487361	2800mm	kit
02.487431	3500mm	kit
Kit F-350G SkyMaster	Para portas de altura até Para puertas con altura hasta Pour portes de hauteur jusqu'à For door heights up to	Com calha de corrente Con guía de cadena Avec rail à chaîne With chain rail
02.410301	2200mm	kit
02.410331	2500mm	kit
02.410361	2800mm	kit
02.410431	3500mm	kit

F-390

MOTOR DE TETO
MOTOR DE TECHO
MOTEUR DE PLAFOND
CEILING MOTOR



F-390G

Alimentação / Alimentación / Alimentation / Power supply	V AC	230
Motor / Motor / Moteur / Motor	V DC	24
Potência / Potencia / Puissance / Power	W	200
Torque / Torque / Moment de force / Torque	N.m	1200
Velocidade / Velocidad / Vitesse / Speed	cm/s	11.0
Área máx. da porta / Tamaño máx. de puerta / Taille max. de porte / Max. door size	m ²	18
Fusível / Fusible / Fusible / Fuse	A (2x)	2,5
Modo económico / Stand-by / Mise en veille / Standby	W	8
Temperatura / Temperatura / Temperature / Temperature	°C	-20 - +50
Frequência / Frecuencia / Fréquence / Frequency	MHz	433 (50m)
Luz de cortesia / Luz de cortesía / Éclairage de courtoisie / Courtesy light	(1x)	LED
Placa de controlo / Central de mando / Logique de commande / Control board	integrada / integrada intégré / integrated	

Kit F-390G SkyMaster	Para portas de altura até Para puertas con altura hasta Pour portes de hauteur jusqu'à For door heights up to	Com calha de corrente Con guía de cadena Avec rail à chaîne With chain rail
02.412431	3500mm	kit
02.412501	4300mm	kit

M 21230

MOTOR DE TETO
MOTOR DE TECHO
MOTEUR DE PLAFOND
CEILING MOTOR



KIT RÁDIO



x 2

KIT BASE

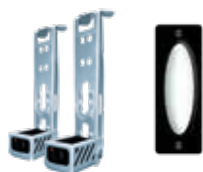

230V



Tensão / Voltaje / Tension / Voltage	V AC	230
Potência / Potencia / Puissance / Power	W	380
Intensidade / Absorción / Intensité / Absorption	A	3,5
Torque / Torque / Moment de force / Torque	N.m	800
Velocidade / Velocidad / Vitesse / Speed	cm / s	13,0
Área máx. da porta / Superficie máxima de la puerta Surface maximale de la porte / Maximum door area	m ²	21

Kit M21230 SkyMaster			Base
02.463125	Para portas de altura até Para puertas con altura hasta Pour portes de hauteur jusqu'a For door heights up to	2500mm	kit
02.463130	Para portas de altura até Para puertas con altura hasta Pour portes de hauteur jusqu'a For door heights up to	3000mm	kit
02.463135	Para portas de altura até Para puertas con altura hasta Pour portes de hauteur jusqu'a For door heights up to	3500mm	kit
02.463145	Para portas de altura até Para puertas con altura hasta Pour portes de hauteur jusqu'a For door heights up to	4500mm	kit
Kit M21230 SkyMaster			Radio
02.463025	Para portas de altura até Para puertas con altura hasta Pour portes de hauteur jusqu'a For door heights up to	2500mm	kit
02.463030	Para portas de altura até Para puertas con altura hasta Pour portes de hauteur jusqu'a For door heights up to	3000mm	kit
02.463035	Para portas de altura até Para puertas con altura hasta Pour portes de hauteur jusqu'a For door heights up to	3500mm	kit
02.463045	Para portas de altura até Para puertas con altura hasta Pour portes de hauteur jusqu'a For door heights up to	4500mm	kit

F-850T/F-890T

MOTOR DE TETO
MOTOR DE TECHO
MOTEUR DE PLAFOND
CEILING MOTOR

SKY Master
Professional



230V
400V

ALU
RESISTANCE

↓
SLIM
↑

⚙️
SAFETY
BREAK

F-850 T F-890 T

	VAC	230	380
Tensão / Voltaje / Tension / Voltage	VAC	230	380
Potência / Potencia / Puissance / Power	W	370	370
Intensidade / Absorción / Intensité / Absorption	A	3,5	1,9
Torque / Torque / Moment de force / Torque	N.m	50	90
Acoplamento / Boca de eje / Emboîture d'arbre / Shaft sleeve	mm / "	25,4/1 "	25,4/1 "
Cabo alimentação / Cable de alimentación / Câble d'alimentation / Power cable	m	8	8
Fins de curso / Finales de carrera / Fin de course / Limit switches	mecânicos / mecánicos mécaniques / mechanical		
Sistema secundário / Sistema secundario / Système secondaire / Secondary system	cadernal / elevador de cadena treuil à chaîne / chain hoist		
Frequência / Frecuencia / Fréquence / Frequency	MHz	433 (50)	433 (50)
Placa de controlo / Central de mando / Logique de commande / Control board	integrada / integrada intégrée /		

Kit F-850 T SkyMaster

02.403110	com quadro integrado con quadro interno avec cadre intégré with integrated board	kit
-----------	---	-----

Kit F-890 T SkyMaster

02.403310	com quadro integrado con quadro interno avec cadre intégré with integrated board	kit
-----------	---	-----

F-850 BX | F-890 BX | F-850 E

MOTOR DE TETO
MOTOR DE TECHO
MOTEUR DE PLAFOND
CEILING MOTOR



		F-850 BX	F-890 BX	F-850 E
Tensão / Voltaje / Tension / Voltage	VAC	230	380	230
Potência / Potencia / Puissance / Power	W	370	370	370
Intensidade / Absorción / Intensité / Absorption	A	35	1.9	3
Torque / Torque / Moment de force / Torque	N.m	50	90	50
Acoplamento / Boca de eje / Emboîture d'arbre / Shaft sleeve	mm / "	25,4/1	25,4/1	25,4/1
Altura máx. / Altura máx. / Hauteur max. / Max. height	m	8	8	8
Fins de curso / Finales de carrera / Fin de course / Limit switches		mecânicos / mecánicos mécaniques / mechanical		encoder encodeur
Sistema secundário / Sistema secundario Système secondaire / Secondary system		cadernal / elevador de cadena treuil à chaîne / chain hoist		
Frequência / Frecuencia / Fréquence / Frequency	MHz	433 (50)	433 (50)	433 (50)

Kit F-850 BX SkyMaster

02.403120	com quadro VARIO externo con quadro VARIO de pared avec cadre VARIO externe with VARIO control station	kit
-----------	---	-----

Kit F-890 BX SkyMaster

02.403320	com quadro VARIO externo con quadro VARIO de pared avec cadre VARIO externe with VARIO control station	kit
-----------	---	-----

Kit F-850 E SkyMaster

02.403150	com quadro VARIO externo con quadro VARIO de pared avec cadre VARIO externe with VARIO control station	kit
-----------	---	-----

OPÇÕES E ACESSÓRIOS

OPCIONES Y ACCESORIOS
 OPTIONS ET ACCESSOIRES
 OPTIONS AND ACCESSORIES



02.400512

Kit segurança fotoeletrico sem fios
 Kit de seguridad fotoeléctrico inalámbrico
 Kit de sécurité photoélectrique sans fil
 Wireless photoelectric security kit

kit



02.400511

Kit eletromagnetico para porta homem sem fios
 Kit electromagnético para puerta de hombre inalámbrica
 Kit électromagnétique pour porte homme sans fil
 Wireless electromagnetic kit for wicket door

kit



02.400018

Selector digital sem fios
 Teclado digital inalámbrico
 Clavier numérique sans fil
 Wireless digital selector

kit



02.400023

Fotocélulas de parede v2011
 Fotocélulas de pared v2011
 Photocellules murales v2011
 Wall photocells v2011

par



02.400033

Fotocélulas de parede v2014
 Fotocélulas de pared v2014
 Photocellules murales v2014
 Wall photocells v2014

par



02.400013

Receptor Mini 4 canais
 Receptor externo 4 canales
 Récepteur externe à 4 canaux
 4 Channel external receiver

uni



02.400035

Desembraiador externo com chave
Desbloqueo exterior con llave
Débrayage externe à clé
External key release

uni



02.401940

Botoneira 3 funções
Mando de pared 3 botones
Bouton mural 3 fonctions
3 functions push button

uni



02.400002

Botoneira de parede sem fios
Mando de pared inalámbrica
Bouton mural sans fil
Wireless push button station

uni



02.400039

Emissor 'black+inox' 4 canais
Mando 'black+inox' 4 canales
Émetteur 'black+inox' 4 canaux
Emitter 'black+inox' 4 channels

uni



02.400028

Pirilampo 230v / 24v led com antena
Lámpara de destellos 230v / led 24v con antena
Feu clignotant à 230v / led 24v avec antenne
230v flasher / 24v led flasher with antenna

uni

> ENCOMENDAS

PEDIDOS | COMMANDES | ORDERS

PT

As encomendas à LM Perfis podem ser formalizadas pelos meios que lhe colocamos à disposição e implicam a aceitação, na íntegra, das Condições Gerais de Venda.

Se, após aceitação, uma encomenda for alterada ou anulada, recairá sobre o Cliente o custo correspondente a 25% do valor de fatura dos itens já produzidos.

FR

Les commandes faites à LM Perfis peuvent être formalisées par les moyens mis à disposition et impliquent l'acceptation, dans sa totalité, des Conditions Générales de Vente.

Si après réception une commande est modifiée ou annulée, le Client en assumera l'entière responsabilité et devra payer le coût correspondant à 25% de la valeur facturée des items produits.

ES

Los Pedidos a la LM Perfis pueden ser formalizados por los medios que ponemos a su disposición e implican la aceptación, en su totalidad, de las Condiciones Generales de Venta.

Si, después de la aceptación, el pedido se cambia o se cancela, recaerá sobre el Cliente lo coste de 25% del valor de la factura de los elementos ya producidos.

EN

Orders placed to LM Perfis may be formalized by the means which we provide and require the complete acceptance of the General Terms of Sale.

If, after acceptance, an order is amended or revoked, the Customer will be charged 25% of invoice value for all the items subject to production.

> CONTACTOS | CONTACTO | CONTACT | CONTACTS

Email Orçamentos	orcamentos@lmpervis.pt
------------------	------------------------

Email Presupuestos	presupuestos@lmpervis.pt
--------------------	--------------------------

Email Devis	france@lmpervis.pt
-------------	--------------------

Quotations Email	orcamentos@lmpervis.pt
------------------	------------------------

Email Encomendas	encomendas@lmpervis.pt
------------------	------------------------

Email Pedidos	pedidos@lmpervis.pt
---------------	---------------------

Email Commandes	france@lmpervis.pt
-----------------	--------------------

Orders Email	encomendas@lmpervis.pt
--------------	------------------------

Telefone Geral / Teléfono General / Téléphone Général / General Telephone	+351 236 620 170
---	------------------

FAX Geral / FAX General / FAX Général / General FAX	+351 236 620 173
---	------------------

Tel. Automatismos / Tel. Automatismos / Tel. Automatismes / Automation Tel.	+351 236 028 018 +351 236 028 020
---	--------------------------------------

» TRANSPORTE

ENTREGAS | LIVRAISON | DELIVERY

PT

Os prazos de fornecimento de material são dados, salvo expresso acordo, a título meramente indicativo

(ver art. 7 das Condições Gerais de Venda).

Os custos com o transporte ficam a cargo do cliente, de acordo com a tabela de preços em vigor.

FR

Les délais de livraison de matériel sont, sauf accord prévu, purement indicatifs (voir article 7 des Conditions Générales de Vente).

Les coûts liés au transport sont à la charge du Client, conformément aux tarifs en vigueur.

ES

Los plazos de suministro de mercancías son dados solamente como indicativos, a menos que se acuerde expresamente otros (ver art. 7 de las Condiciones Generales de Venta).

Los costes del transporte corren a cargo del Cliente, de acuerdo con la tarifa en vigor.

EN

The given delivery deadlines are general estimations, unless otherwise stated (see art. 7 of the General Terms of Sale).

Shipping costs will be charged to the customer, according to the last price list.

» APOIO AO CLIENTE

SERVICIO AL CLIENTE | SERVICE CLIENT | CUSTOMER SERVICE

PT

Contacte-nos em caso de qualquer dúvida, informação ou reclamação. Teremos todo o gosto em lhe prestar o apoio necessário.

FR

Contactez-nous en cas d'incertitude, d'information ou réclamation. Nous aurons tous le plaisir de vous fournir l'aide nécessaire.

ES

Contáctenos para cualquier tipo de aclaración, sugerencia o reclamación. Nos encanta proporcionarle todo el apoyo necesario.

EN

Contact us if you have any questions, requests of information or complaints. We will be happy to provide you with the necessary support.

» CONTACTOS | CONTACTO | CONTACT | CONTACTS

Dep. Comercial / Dep. Comercial / Service Commercial / Sales Dept.

comercial@lmpersis.pt

Dep. Apoio ao Cliente / Apoio al cliente / Dep. SAV / Customer Care Dept.

apoiocliente@lmpersis.pt

Dep. Comunicação e Marketing / Dep. Marketing / Service Marketing / Marketing

design@lmpersis.pt

Dep. Automatismos / Dep. Automatismos / Ser. Automatismes / Automation Dept.

automatismos@lmpersis.pt

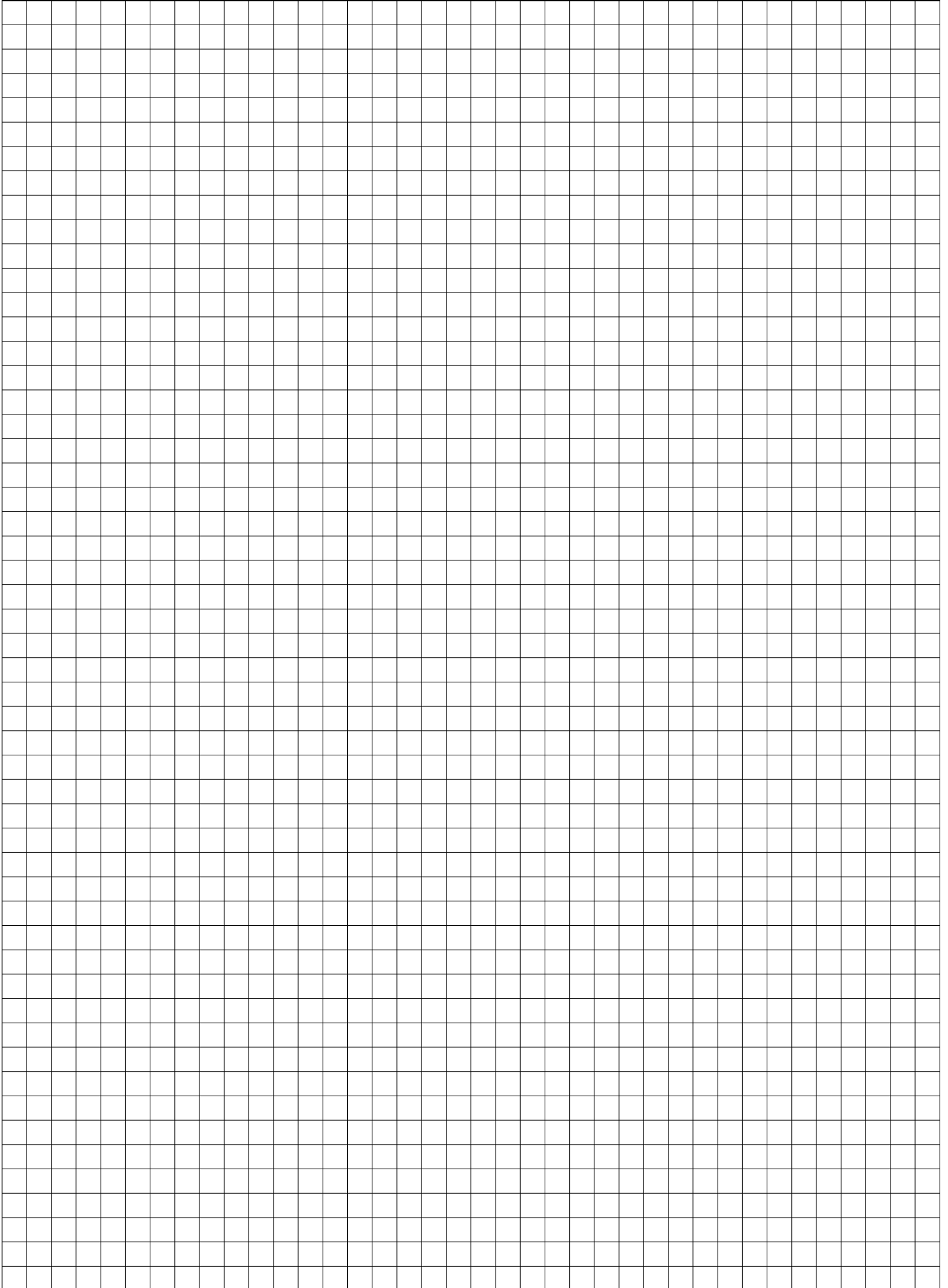

> LM PERFIS | INDÚSTRIA DE PERFIS E PORTAS, S.A.

Zona Industrial do Camporês, Rua Azul
Lote 26-27 | Chão de Couce
3240 - 509 Ansião | Portugal

t +351 236 620 170

f +351 236 620 173

info@lmpersis.pt

www.lmpersis.pt

Técnico Comercial / Técnico Comercial / Technicien commercial / Sales Technician

Telemóvel/ Teléfono móvil / Téléphone mobile / Mobile phone

Email



www.lmperfis.pt